

## Deutsch

### Normen:

BÄNNINGER – Kleb- und Gewindefittings aus PVC-U werden der Norm DIN 8063 entsprechend hergestellt und erfüllen darüberhinaus auch die Anforderungen der Normen ISO 727, UNI 7442/75, NF T 54-028, KIWA 54-PN 16 u. a. Die Baumaße sind in mm angegeben.

### Werkstoff:

PVC-U (PVC-hart) = Polyvinylchlorid ohne Weichmacher. Farbe grau, entsprechend dem Standard für Druckleitungen aus PVC-hart. Dieses Material entspricht den Empfehlungen des Deutschen Bundesgesundheitsamtes, veröffentlicht im Bundesgesundheitsblatt Nr. 23 von 1964. Hinsichtlich seiner chemischen Widerstandsfähigkeit verweisen wir auf die Norm DIN 8061 – Beiblatt 1 und unsere „Technische Information: Chemische Beständigkeit“.

### Verbindung:

**Kleerverbindung:** BÄNNINGER Kleb- und Übergangsfittings sind geeignet zum Verbinden von PVC-U-Rohren, deren Außendurchmesser-Toleranzen der DIN 8062 bzw. ISO 3606 entsprechen. Fordern Sie hierzu im Bedarfsfalle unsere ausführliche Verlegeanleitung an.  
**Gewindeverbindung:** Die Anschlussgewinde der BÄNNINGER Übergangsfittings mit Verstärkungsring entsprechen den Normen DIN 2999 bzw. ISO 7 – zylindrisches Innengewinde – kegliges Außengewinde. Die Innengewinde der BÄNNINGER Gewindefittings ohne Verstärkungsring sind kegelig entsprechend der ISO 7 ausgeführt.

Das Eindichten von PVC-U-Gewindeteilen ist ausschließlich mit PTFE-Band vorzunehmen. Hanf und Dichtpaste sind ungeeignet und dürfen nicht verwendet werden.

### Klebstoff:

Für die Herstellung von Klebverbindungen ist die Verwendung eines Klebstoffs auf Basis THF unbedingt erforderlich. Unsere diesbezügliche Verlegeanleitung basiert auf der Verwendung von TANGIT-Klebstoff.

### Betriebsdruck:

Sofern keine andere Angabe: Richtwert für Kleb- und Übergangsfittings: PN 16 = 16 bar bei 20° C (Wasser).

Richtwert für Übergangs- und Gewindefittings und Verschraubungen: PN 10 = 10 bar bei 20° C (Wasser).

Der zulässige Druck ist der jeweiligen Modell-Maßtabelle zu entnehmen.

### Kennzeichnung:

BÄNNINGER – Kleb- und Übergangsfittings sind wie folgt gekennzeichnet:

- **BR**
- Rohraußendurchmesser bzw. Gewinde-Anschlussgröße und Nennweite
- PVC-U (=PVC hart).

BÄNNINGER-Gewindefittings sind wie folgt gekennzeichnet:

- **BR**
- Gewinde-Anschlussgröße
- PVC-U (=PVC hart).

BÄNNINGER PVC-U Fittings werden bezeichnet durch die Angabe:

- der Form (z.B. Bogen, Winkel, T, Muffe usw.)
- der Katalog-Nr. (=Bestell-Nr.)
- der Abmessung (z.B. d 32 bzw. d 32-1 bzw.1).

Bei Bestellung sind mindestens anzugeben:

- die Katalog-Nr. (=Bestell-Nr.)
- die Abmessung
- die Stückzahl.

### Zeichenerklärung:

- d = Rohraußendurchmesser
- R = Kegeliges Rohraußengewinde
- Rp = Zylindrisches Innengewinde
- Rc = Kegeliges Rohrinngewinde
- G = Zylindrisches Außengewinde
- DN = Nennweite
- Stp. = Standardpackung, Mengenangabe in Stück
- AL = Anzahl der Schraubenlöcher
- ® = Eingetragenes Markenzeichen
- PVC-U = Polyvinylchlorid
- EPDM = Äthylen-Propylen-Kautschuk
- FPM = Fluor-Kautschuk z. B. VITON®
- GTW = Temperguss
- Rg = Rotguss

### Kleblängen:

In den Maßtabellen dieses Kataloges sind die Kleblängen nicht gesondert ausgewiesen. Diese sind bei Bedarf generell der folgenden Tabelle zu entnehmen:

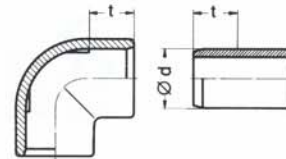

| Rohr Ø d (mm) | Muffentiefe = Einschiebtiefe t (mm) |
|---------------|-------------------------------------|
| 10            | 12                                  |
| 12            | 12                                  |
| 16            | 14                                  |
| 20            | 16                                  |
| 25            | 19                                  |
| 32            | 22                                  |
| 40            | 26                                  |
| 50            | 31                                  |
| 63            | 38                                  |
| 75            | 44                                  |
| 90            | 51                                  |
| 110           | 61                                  |
| 140           | 76                                  |
| 160           | 86                                  |
| 225           | 119                                 |
| 250           | 131                                 |
| 280           | 146                                 |
| 315           | 164                                 |

**Bogen 90°** mit beidseitiger Klebmuffe  
 Bend 90°  
 Courbe à 90°  
 Curva 90°

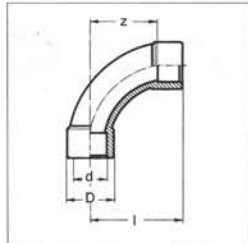

| d   | DN  | D   | l   | z   | Stp. | bar |
|-----|-----|-----|-----|-----|------|-----|
| 16  | 10  | 23  | 46  | 32  | 5    | 16  |
| 20  | 15  | 27  | 56  | 40  | 5    | 16  |
| 25  | 20  | 35  | 69  | 50  | 5    | 16  |
| 32  | 25  | 40  | 86  | 64  | 2    | 16  |
| 40  | 32  | 49  | 106 | 80  | 2    | 16  |
| 50  | 40  | 61  | 131 | 100 | 5    | 16  |
| 63  | 50  | 76  | 164 | 126 | 2    | 16  |
| 75  | 65  | 94  | 190 | 149 | 2    | 16  |
| 90  | 80  | 112 | 231 | 180 | 1    | 16  |
| 110 | 100 | 137 | 283 | 222 | 1    | 16  |
| 140 | 125 | 167 | 355 | 280 | 1    | 16  |
| 160 | 150 | 190 | 410 | 319 | 1    | 16  |

**Winkel 90°** mit beidseitiger Klebmuffe  
 Elbow 90°  
 Coude à 90°  
 Codo 90°

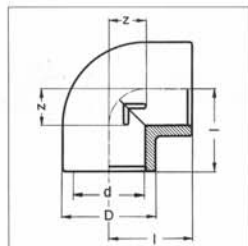

| d   | DN  | D   | l   | z   | Stp. | bar |
|-----|-----|-----|-----|-----|------|-----|
| 10  | 6   | 14  | 18  | 6   | 10   | 16  |
| 12  | 8   | 17  | 19  | 7   | 10   | 16  |
| 16  | 10  | 23  | 23  | 9   | 10   | 16  |
| 20  | 15  | 28  | 27  | 11  | 10   | 16  |
| 25  | 20  | 32  | 33  | 14  | 10   | 16  |
| 32  | 25  | 40  | 39  | 17  | 10   | 16  |
| 40  | 32  | 49  | 49  | 23  | 10   | 16  |
| 50  | 40  | 61  | 59  | 27  | 10   | 16  |
| 63  | 50  | 75  | 72  | 34  | 5    | 16  |
| 75  | 65  | 92  | 82  | 39  | 2    | 16  |
| 90  | 80  | 110 | 97  | 46  | 2    | 16  |
| 110 | 100 | 132 | 117 | 56  | 2    | 16  |
| 140 | 125 | 167 | 147 | 71  | 1    | 16  |
| 160 | 150 | 190 | 167 | 81  | 1    | 16  |
| 225 | 200 | 256 | 233 | 114 | 1    | 10  |
| 250 | 225 | 286 | 317 | 186 | 1    | 10  |
| 280 | 250 | 319 | 357 | 210 | 1    | 10  |
| 315 | 300 | 360 | 401 | 236 | 1    | 10  |

**Winkel 45°** mit beidseitiger Klebmuffe  
 Elbow 45°  
 Coude à 45°  
 Codo 45°

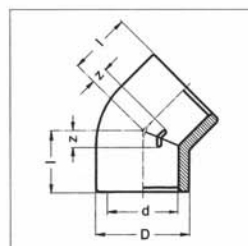

| d   | DN  | D   | l   | z  | Stp. | bar |
|-----|-----|-----|-----|----|------|-----|
| 16  | 10  | 23  | 19  | 5  | 10   | 16  |
| 20  | 15  | 28  | 21  | 5  | 10   | 16  |
| 25  | 20  | 34  | 25  | 6  | 10   | 16  |
| 32  | 25  | 41  | 30  | 8  | 10   | 16  |
| 40  | 32  | 51  | 36  | 10 | 5    | 16  |
| 50  | 40  | 61  | 43  | 12 | 5    | 16  |
| 63  | 50  | 77  | 52  | 14 | 5    | 16  |
| 75  | 65  | 90  | 60  | 17 | 2    | 16  |
| 90  | 80  | 110 | 71  | 20 | 2    | 16  |
| 110 | 100 | 132 | 85  | 24 | 2    | 16  |
| 140 | 125 | 164 | 105 | 30 | 1    | 16  |
| 160 | 150 | 188 | 120 | 34 | 1    | 16  |
| 225 | 200 | 259 | 172 | 49 | 1    | 10  |
| 250 | 225 | 287 | 190 | 58 | 1    | 10  |
| 280 | 250 | 320 | 208 | 62 | 1    | 10  |
| 315 | 300 | 360 | 232 | 68 | 1    | 10  |

**T-Stück 90° mit allseitiger Klebmuffe**

Tee 90°  
 Té à 90°  
 Te 90°

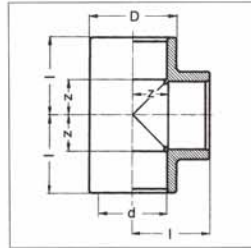

| d   | DN  | D   | l   | z   | Stp. | bar |
|-----|-----|-----|-----|-----|------|-----|
| 10  | 6   | 16  | 19  | 6   | 10   | 16  |
| 12  | 8   | 19  | 20  | 7   | 10   | 16  |
| 16  | 10  | 23  | 23  | 9   | 10   | 16  |
| 20  | 15  | 28  | 27  | 11  | 10   | 16  |
| 25  | 20  | 34  | 33  | 14  | 10   | 16  |
| 32  | 25  | 41  | 39  | 17  | 10   | 16  |
| 40  | 32  | 49  | 47  | 21  | 5    | 16  |
| 50  | 40  | 62  | 57  | 26  | 10   | 16  |
| 63  | 50  | 77  | 72  | 34  | 5    | 16  |
| 75  | 65  | 92  | 84  | 39  | 2    | 16  |
| 90  | 80  | 110 | 97  | 46  | 2    | 16  |
| 110 | 100 | 132 | 117 | 56  | 2    | 16  |
| 140 | 125 | 170 | 149 | 73  | 1    | 16  |
| 160 | 150 | 191 | 169 | 83  | 1    | 16  |
| 225 | 200 | 256 | 233 | 114 | 1    | 10  |
| 250 | 225 | 286 | 261 | 132 | 1    | 10  |
| 280 | 250 | 319 | 290 | 144 | 1    | 10  |
| 315 | 300 | 360 | 326 | 162 | 1    | 10  |

**T-Stück 90° red. mit allseitiger Klebmuffe**

Tee 90°  
 Té à 90°  
 Te 90° con salida reducida

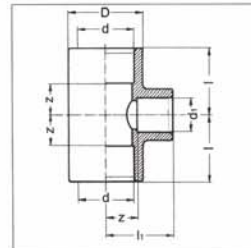

| d - d <sub>1</sub> - d | DN          | D   | l   | l <sub>1</sub> | z   | Stp. | bar |
|------------------------|-------------|-----|-----|----------------|-----|------|-----|
| 25- 20- 25             | 20- 15- 20  | 33  | 33  | 30             | 14  | 10   | 16  |
| 32- 20- 32             | 25- 15- 25  | 41  | 39  | 33             | 17  | 10   | 16  |
| 32- 25- 32             | 25- 20- 25  | 41  | 39  | 36             | 17  | 10   | 16  |
| 40- 20- 40             | 32- 15- 32  | 50  | 49  | 39             | 24  | 10   | 16  |
| 40- 25- 40             | 32- 20- 32  | 50  | 49  | 42             | 24  | 10   | 16  |
| 40- 32- 40             | 32- 25- 32  | 50  | 49  | 45             | 24  | 10   | 16  |
| 50- 20- 50             | 40- 15- 40  | 62  | 59  | 44             | 28  | 10   | 16  |
| 50- 25- 50             | 40- 20- 40  | 62  | 59  | 47             | 28  | 10   | 16  |
| 50- 32- 50             | 40- 25- 40  | 62  | 57  | 48             | 26  | 10   | 16  |
| 50- 40- 50             | 40- 32- 40  | 62  | 59  | 54             | 28  | 10   | 16  |
| 63- 20- 63             | 50- 15- 50  | 75  | 71  | 51             | 33  | 5    | 16  |
| 63- 25- 63             | 50- 20- 50  | 75  | 71  | 53             | 33  | 5    | 16  |
| 63- 32- 63             | 50- 25- 50  | 75  | 71  | 56             | 33  | 5    | 16  |
| 63- 40- 63             | 50- 32- 50  | 75  | 71  | 60             | 33  | 5    | 16  |
| 63- 50- 63             | 50- 40- 50  | 75  | 71  | 65             | 33  | 5    | 16  |
| 75- 50- 75             | 65- 40- 65  | 92  | 84  | 72             | 39  | 5    | 16  |
| 75- 63- 75             | 65- 50- 65  | 92  | 84  | 79             | 39  | 5    | 16  |
| 90- 63- 90             | 80- 50- 80  | 110 | 97  | 93             | 46  | 1    | 16  |
| 90- 75- 90             | 80- 65- 80  | 110 | 97  | 99             | 46  | 1    | 16  |
| 110- 90-110            | 100- 80-100 | 132 | 117 | 116            | 56  | 1    | 16  |
| 160-110-160            | 150-100-150 | 191 | 169 | 142            | 83  | 1    | 16  |
| 225-160-225            | 200-150-200 | 256 | 233 | 205            | 114 | 1    | 10  |

**Abzweig 45° mit allseitiger Klebmuffe**

Tee 45°  
 Té à 45°  
 Te 45°

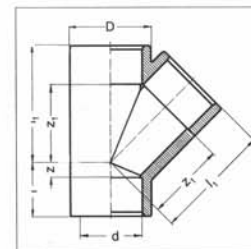

| d   | DN  | D   | l  | l <sub>1</sub> | z  | z <sub>1</sub> | Stp. | bar |
|-----|-----|-----|----|----------------|----|----------------|------|-----|
| 20  | 15  | 28  | 23 | 47             | 5  | 30             | 10   | 10  |
| 25  | 20  | 33  | 28 | 56             | 6  | 37             | 10   | 10  |
| 32  | 25  | 41  | 29 | 61             | 7  | 39             | 10   | 10  |
| 40  | 32  | 51  | 35 | 75             | 9  | 49             | 10   | 10  |
| 50  | 40  | 63  | 42 | 92             | 11 | 61             | 5    | 10  |
| 63  | 50  | 77  | 52 | 115            | 14 | 77             | 5    | 10  |
| 75  | 65  | 90  | 63 | 144            | 19 | 100            | 2    | 6   |
| 90  | 80  | 107 | 70 | 175            | 19 | 116            | 1    | 6   |
| 110 | 100 | 136 | 88 | 210            | 27 | 148            | 1    | 6   |

**Kreuz mit allseitiger Klebmuffe**

Cross  
 Croix  
 Cruz

621.30.01

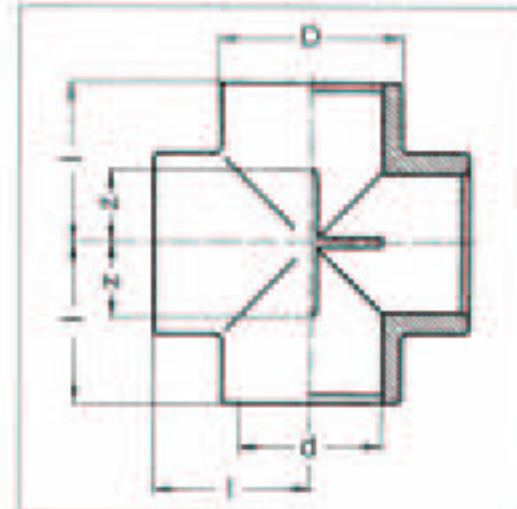

| d  | DN | D  | l  | z  | Stp. | bar |
|----|----|----|----|----|------|-----|
| 25 | 20 | 34 | 32 | 14 | 10   | 16  |
| 32 | 25 | 40 | 39 | 17 | 10   | 16  |
| 40 | 32 | 51 | 47 | 21 | 10   | 16  |
| 50 | 40 | 63 | 57 | 26 | 10   | 16  |
| 63 | 50 | 77 | 70 | 34 | 5    | 16  |

**Rohrverschraubung mit einseitiger Klebmuffe und Blinddeckel; Runddichtring EPDM**

**Einzelteile:** Blinddeckel 621.60.00, Seite 11  
 Einschraubteil 621.64.01, Seite 11  
 Überwurfmutter 621.69.00, Seite 11  
 Runddichtring 648.41.00, Seite 28  
 Runddichtring 649.41.00, Seite 28

Union • Machon union • Unión roscada

621.51.00

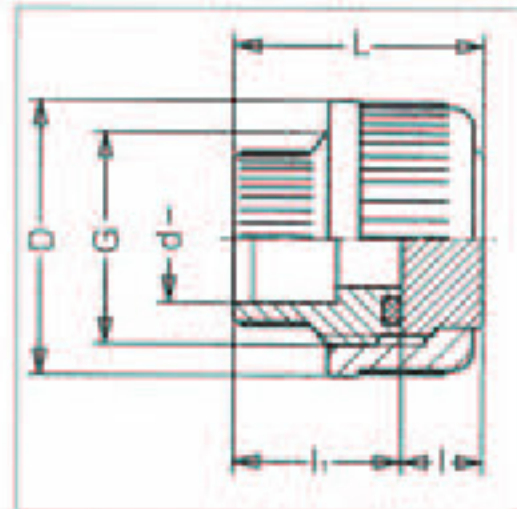

| d  | DN | G     | L  | l  | li | D   | Stp. | bar |
|----|----|-------|----|----|----|-----|------|-----|
| 20 | 15 | 1     | 38 | 12 | 26 | 43  | 10   | 10  |
| 25 | 20 | 1 1/4 | 45 | 15 | 30 | 53  | 10   | 10  |
| 32 | 25 | 1 1/2 | 47 | 15 | 32 | 60  | 10   | 10  |
| 40 | 32 | 2     | 55 | 17 | 38 | 74  | 10   | 10  |
| 50 | 40 | 2 1/4 | 61 | 17 | 44 | 83  | 10   | 10  |
| 63 | 50 | 2 3/4 | 75 | 20 | 55 | 103 | 2    | 10  |

**Rohrverschraubung mit beidseitiger Klebmuffe; Runddichtring EPDM**

**Einzelteile:** Einlegteil 621.60.01, Seite 11  
 Einschraubteil 621.64.01, Seite 11  
 Überwurfmutter 621.69.00, Seite 11  
 Runddichtring 648.41.00, Seite 28  
 Runddichtring 649.41.00, Seite 28

Union • Machon union • Unión roscada

621.51.01

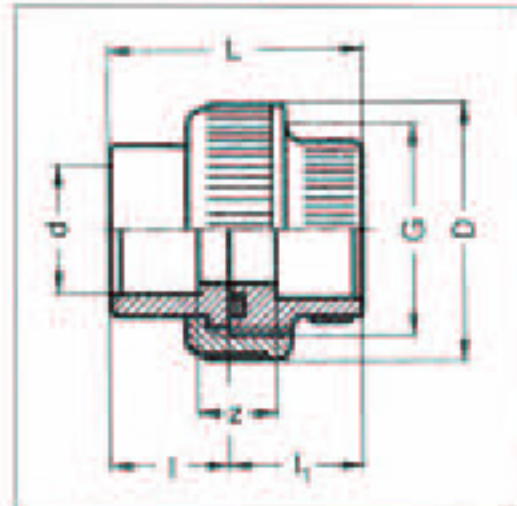

| d   | DN  | G     | L   | l  | li | z  | D   | Stp. | bar |
|-----|-----|-------|-----|----|----|----|-----|------|-----|
| 10  | 6   | 3/8   | 37  | 15 | 22 | 13 | 31  | 10   | 10  |
| 12  | 8   | 3/8   | 37  | 15 | 22 | 13 | 31  | 10   | 10  |
| 16  | 10  | 3/4   | 41  | 17 | 24 | 13 | 35  | 10   | 10  |
| 20  | 15  | 1     | 46  | 19 | 26 | 13 | 43  | 10   | 10  |
| 25  | 20  | 1 1/4 | 52  | 22 | 30 | 13 | 53  | 10   | 10  |
| 32  | 25  | 1 1/2 | 57  | 25 | 32 | 13 | 60  | 10   | 10  |
| 40  | 32  | 2     | 68  | 30 | 38 | 15 | 74  | 10   | 10  |
| 50  | 40  | 2 1/4 | 79  | 35 | 44 | 17 | 83  | 10   | 10  |
| 63  | 50  | 2 3/4 | 97  | 41 | 55 | 21 | 103 | 2    | 10  |
| 75  | 65  | 3 1/2 | 108 | 47 | 61 | 20 | 122 | 2    | 10  |
| 90  | 80  | 4     | 124 | 56 | 68 | 22 | 139 | 1    | 6   |
| 110 | 100 | 5     | 138 | 66 | 72 | 16 | 164 | 1    | 6   |

**Klebfittings • Pipe Fittings for solvent cement jointing**  
**Raccords à coller • Accesorios para encolar**



**Blinddeckel PVC-U – gedreht – zum Einlegen in Überwurfmutter**

für Rohrverschraubung (Art.-Nr. 621.51.01) und Kugelhahn (Art.-Nr. 621.342.250/275) – Dichtfläche flach –  
 Blank cover PVC-U – manufactured by turning – To insert in the union nut  
 of the adaptor pipe fittings (Art.-N° 621.51.01) and ball valves (Art.-N° 621.342.250/275). Flat joint.

Bouchon d'obturation en PVC-U – usiné – A insérer dans l'écrou

de l'union 3 pièces (Art.-Nr. 621.51.01) et du vanne a bille (Art.-Nr. 621.342.250/275). Siège plat.

Tapa PVC-U – girado – para meter en tuerca de uniones (art-no. 621.51.01) y valvulas de esfera (art-no. 621.342.250/275), junta plana.

621.60.00

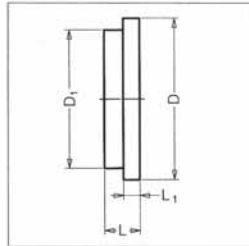

| d  | DN | D    | D <sub>1</sub> | L  | L <sub>1</sub> |
|----|----|------|----------------|----|----------------|
| 20 | 15 | 30   | 27,5           | 12 | 5,5            |
| 25 | 20 | 39   | 36             | 15 | 7              |
| 32 | 25 | 44,3 | 41,2           | 15 | 6,8            |
| 40 | 32 | 56   | 53             | 17 | 8              |
| 50 | 40 | 62,5 | 59             | 17 | 7              |
| 63 | 50 | 78   | 73,7           | 20 | 9              |

**Einlegeteil mit Klebmuffe**

Union end

Pièce folle

Pieza loca

621.60.01

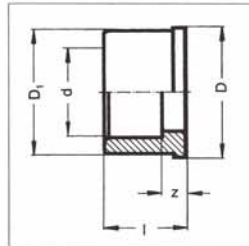

| d   | DN  | D <sub>1</sub> | D     | l  | z | Stp. | bar |
|-----|-----|----------------|-------|----|---|------|-----|
| 10  | 6   | 19             | 20    | 15 | 3 | 10   | 10  |
| 12  | 8   | 19             | 20    | 15 | 3 | 10   | 10  |
| 16  | 10  | 22             | 24    | 17 | 3 | 50   | 10  |
| 20  | 15  | 27,5           | 30,1  | 19 | 3 | 50   | 10  |
| 25  | 20  | 36             | 38,8  | 22 | 3 | 50   | 10  |
| 32  | 25  | 41,5           | 44,7  | 25 | 3 | 50   | 10  |
| 40  | 32  | 53             | 56,5  | 29 | 3 | 10   | 10  |
| 50  | 40  | 59             | 62,6  | 34 | 3 | 10   | 10  |
| 63  | 50  | 74             | 78,4  | 41 | 3 | 5    | 10  |
| 75  | 65  | 92,5           | 97,2  | 47 | 3 | 5    | 10  |
| 90  | 80  | 105            | 110   | 56 | 5 | 5    | 6   |
| 110 | 100 | 129            | 134,4 | 66 | 5 | 5    | 6   |

**Einschraubteil mit Klebmuffe; Runddichtring**

Union bush

Pièce filetée

Pieza roscada

621.64.01

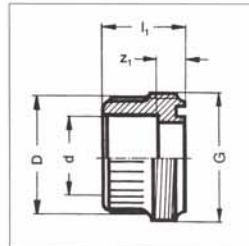

| d   | DN  | G                           | D   | l <sub>1</sub> | z <sub>1</sub> | Stp. | bar |
|-----|-----|-----------------------------|-----|----------------|----------------|------|-----|
| 10  | 6   | <sup>5</sup> / <sub>8</sub> | 20  | 23             | 10             | 10   | 10  |
| 12  | 8   | <sup>5</sup> / <sub>8</sub> | 20  | 23             | 10             | 10   | 10  |
| 16  | 10  | <sup>3</sup> / <sub>4</sub> | 23  | 24             | 10             | 50   | 10  |
| 20  | 15  | 1                           | 28  | 26             | 10             | 50   | 10  |
| 25  | 20  | 1 1/4                       | 33  | 29             | 10             | 50   | 10  |
| 32  | 25  | 1 1/2                       | 40  | 31             | 10             | 50   | 10  |
| 40  | 32  | 2                           | 50  | 38             | 12             | 10   | 10  |
| 50  | 40  | 2 1/4                       | 61  | 44             | 14             | 10   | 10  |
| 63  | 50  | 2 3/4                       | 76  | 55             | 18             | 5    | 10  |
| 75  | 65  | 3 1/2                       | 96  | 61             | 17             | 5    | 10  |
| 90  | 80  | 4                           | 109 | 68             | 17             | 5    | 6   |
| 110 | 100 | 5                           | 133 | 72             | 11             | 5    | 6   |

**Überwurfmutter**

Union nut

Ecrou

Tuerca

621.69.00

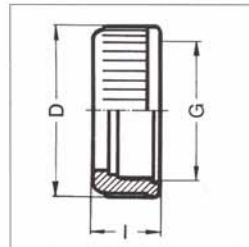

| d   | DN  | G                           | D   | l  | Stp. | bar |
|-----|-----|-----------------------------|-----|----|------|-----|
| 10  | 6   | <sup>5</sup> / <sub>8</sub> | 29  | 19 | 10   | 10  |
| 12  | 8   | <sup>5</sup> / <sub>8</sub> | 29  | 19 | 10   | 10  |
| 16  | 10  | <sup>3</sup> / <sub>4</sub> | 33  | 22 | 50   | 10  |
| 20  | 15  | 1                           | 41  | 23 | 50   | 10  |
| 25  | 20  | 1 1/4                       | 51  | 25 | 50   | 10  |
| 32  | 25  | 1 1/2                       | 58  | 27 | 50   | 10  |
| 40  | 32  | 2                           | 72  | 30 | 10   | 10  |
| 50  | 40  | 2 1/4                       | 80  | 34 | 10   | 10  |
| 63  | 50  | 2 3/4                       | 100 | 38 | 5    | 10  |
| 75  | 65  | 3 1/2                       | 118 | 43 | 5    | 10  |
| 90  | 80  | 4                           | 134 | 45 | 5    | 6   |
| 110 | 100 | 5                           | 159 | 51 | 5    | 6   |

**Bundbuchse** für Flachdichtung;  
Dichtfläche gerillt; Auswahlübersicht auf Seite 30  
Flange adaptor  
Collet  
Collar

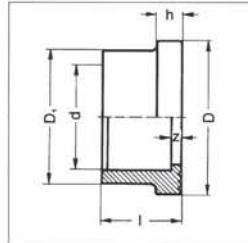

| d   | DN  | D   | D <sub>1</sub> | l   | z | h  | Stp. | bar |
|-----|-----|-----|----------------|-----|---|----|------|-----|
| 20  | 15  | 34  | 27             | 19  | 3 | 6  | 10   | 16  |
| 25  | 20  | 41  | 33             | 22  | 3 | 7  | 10   | 16  |
| 32  | 25  | 50  | 41             | 25  | 3 | 7  | 10   | 16  |
| 40  | 32  | 61  | 50             | 29  | 3 | 8  | 10   | 16  |
| 50  | 40  | 73  | 61             | 34  | 3 | 8  | 10   | 16  |
| 63  | 50  | 90  | 76             | 41  | 3 | 9  | 2    | 16  |
| 75  | 65  | 106 | 90             | 47  | 3 | 10 | 2    | 16  |
| 90  | 80  | 125 | 108            | 56  | 5 | 11 | 2    | 16  |
| 110 | 100 | 150 | 131            | 66  | 5 | 12 | 2    | 16  |
| 140 | 125 | 188 | 165            | 81  | 5 | 14 | 2    | 16  |
| 160 | 150 | 213 | 188            | 91  | 5 | 16 | 2    | 16  |
| 225 | 200 | 274 | 248            | 125 | 6 | 25 | 1    | 10  |
| 250 | 225 | 328 | 282            | 139 | 9 | 25 | 1    | 10  |
| 280 | 250 | 327 | 306            | 154 | 9 | 27 | 1    | 10  |
| 315 | 300 | 377 | 342            | 173 | 9 | 30 | 1    | 10  |

**Bundbuchse** für Flach- und Runddichtung  
Auswahlübersicht auf Seite 30  
Flange adaptor  
Collet  
Collar

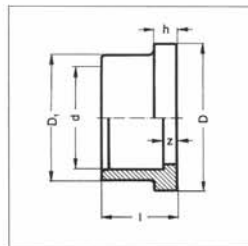

| d   | DN  | D   | D <sub>1</sub> | l   | z | h  | Stp. | bar |
|-----|-----|-----|----------------|-----|---|----|------|-----|
| 16  | 10  | 29  | 22             | 17  | 3 | 6  | 10   | 16  |
| 20  | 15  | 34  | 27             | 19  | 3 | 6  | 10   | 16  |
| 25  | 20  | 41  | 33             | 22  | 3 | 7  | 10   | 16  |
| 32  | 25  | 50  | 41             | 25  | 3 | 7  | 10   | 16  |
| 40  | 32  | 61  | 50             | 29  | 3 | 8  | 10   | 16  |
| 50  | 40  | 73  | 61             | 34  | 3 | 8  | 10   | 16  |
| 63  | 50  | 90  | 76             | 41  | 3 | 9  | 2    | 16  |
| 75  | 65  | 106 | 90             | 47  | 3 | 10 | 2    | 16  |
| 90  | 80  | 125 | 108            | 56  | 5 | 11 | 2    | 16  |
| 110 | 100 | 150 | 131            | 66  | 5 | 12 | 2    | 16  |
| 140 | 125 | 188 | 165            | 81  | 5 | 14 | 2    | 16  |
| 160 | 150 | 213 | 188            | 91  | 5 | 16 | 2    | 16  |
| 225 | 200 | 274 | 248            | 125 | 6 | 25 | 1    | 10  |

**Bundbuchse** mit O-Ring Kammer  
Auswahlübersicht auf Seite 30  
Flange adaptor  
Collet  
Collar

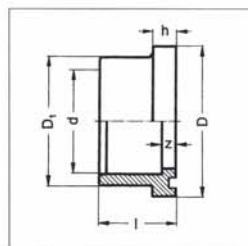

| d   | DN  | D   | D <sub>1</sub> | l   | z  | h  | Stp. | bar |
|-----|-----|-----|----------------|-----|----|----|------|-----|
| 16  | 10  | 29  | 22             | 20  | 6  | 9  | 10   | 16  |
| 20  | 15  | 34  | 27             | 22  | 6  | 9  | 10   | 16  |
| 25  | 20  | 41  | 33             | 25  | 6  | 10 | 10   | 16  |
| 32  | 25  | 50  | 41             | 28  | 6  | 10 | 10   | 16  |
| 40  | 32  | 61  | 50             | 34  | 8  | 13 | 10   | 16  |
| 50  | 40  | 73  | 61             | 39  | 8  | 13 | 10   | 16  |
| 63  | 50  | 90  | 76             | 46  | 8  | 14 | 2    | 16  |
| 75  | 65  | 106 | 90             | 52  | 8  | 15 | 2    | 16  |
| 90  | 80  | 125 | 108            | 61  | 10 | 16 | 2    | 16  |
| 110 | 100 | 150 | 131            | 72  | 11 | 18 | 2    | 16  |
| 140 | 125 | 188 | 165            | 87  | 11 | 20 | 2    | 16  |
| 160 | 150 | 213 | 188            | 97  | 11 | 22 | 1    | 16  |
| 225 | 200 | 274 | 248            | 131 | 12 | 31 | 1    | 10  |

**Lose Flansche aus PVC-U** für Bundbuchsen  
Anschlussmaße nach PN 10  
Backing Flanges PVC-U for Flange Adaptor  
Brides Libres PVC-U pour collets à souder  
Bridas sueltas de PVC-U para collares a soldar

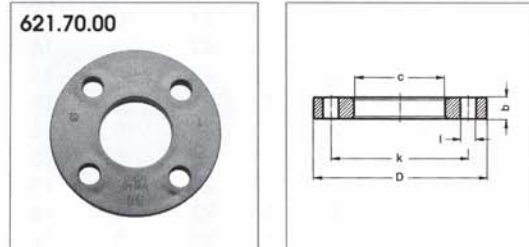

| d   | DN  | D   | k   | b  | c   | l  | AL | Stp. |
|-----|-----|-----|-----|----|-----|----|----|------|
| 16  | 10  | 90  | 60  | 12 | 23  | 14 | 4  | 5    |
| 20  | 15  | 95  | 65  | 12 | 28  | 14 | 4  | 5    |
| 25  | 20  | 105 | 75  | 14 | 34  | 14 | 4  | 5    |
| 32  | 25  | 115 | 85  | 15 | 42  | 14 | 4  | 5    |
| 40  | 32  | 140 | 100 | 15 | 51  | 18 | 4  | 5    |
| 50  | 40  | 150 | 110 | 16 | 62  | 18 | 4  | 5    |
| 63  | 50  | 165 | 125 | 18 | 78  | 18 | 4  | 5    |
| 75  | 65  | 185 | 145 | 19 | 92  | 18 | 4  | 5    |
| 90  | 80  | 200 | 160 | 20 | 110 | 18 | 8  | 5    |
| 110 | 100 | 220 | 180 | 22 | 133 | 18 | 8  | 5    |
| 140 | 125 | 250 | 210 | 26 | 167 | 18 | 8  | 5    |
| 160 | 150 | 285 | 240 | 28 | 190 | 22 | 8  | 5    |
| 225 | 200 | 340 | 295 | 30 | 250 | 22 | 8  | 5    |
| 250 | 250 | 399 | 325 | 32 | 285 | 22 | 12 | 1    |
| 280 | 250 | 399 | 350 | 32 | 307 | 22 | 12 | 1    |
| 315 | 300 | 450 | 400 | 34 | 345 | 22 | 12 | 1    |

**Lose Flansche aus Polypropylen m. Stahleinlage**  
für Bundbuchsen; Anschlussmaße nach PN 10  
Backing Flanges PP/St for Flange Adaptor  
Brides Libres PP/St pour collets à souder  
Bridas sueltas de PP/St para collares a soldar

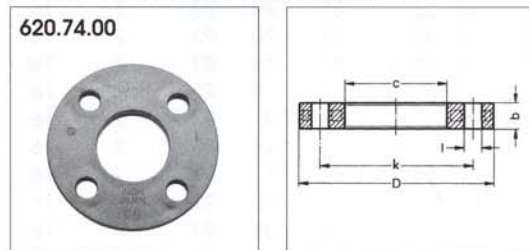

| d   | DN  | D   | k   | b  | c   | l  | AL | Stp. |
|-----|-----|-----|-----|----|-----|----|----|------|
| 20  | 15  | 95  | 65  | 12 | 28  | 14 | 4  | 2    |
| 25  | 20  | 105 | 75  | 14 | 34  | 14 | 4  | 2    |
| 32  | 25  | 115 | 85  | 14 | 42  | 14 | 4  | 2    |
| 40  | 32  | 140 | 100 | 16 | 51  | 18 | 4  | 2    |
| 50  | 40  | 150 | 110 | 18 | 62  | 18 | 4  | 2    |
| 63  | 50  | 165 | 125 | 18 | 78  | 18 | 4  | 2    |
| 75  | 65  | 185 | 145 | 18 | 92  | 18 | 4  | 2    |
| 90  | 80  | 200 | 160 | 18 | 110 | 18 | 8  | 2    |
| 110 | 100 | 220 | 180 | 18 | 133 | 18 | 8  | 2    |
| 125 | 100 | 220 | 180 | 18 | 149 | 18 | 8  | 2    |
| 140 | 125 | 250 | 210 | 24 | 167 | 18 | 8  | 2    |
| 160 | 150 | 285 | 240 | 24 | 190 | 22 | 8  | 2    |
| 225 | 200 | 340 | 295 | 24 | 250 | 22 | 8  | 2    |

**Muffe**  
Socket  
Manchon  
Manguito

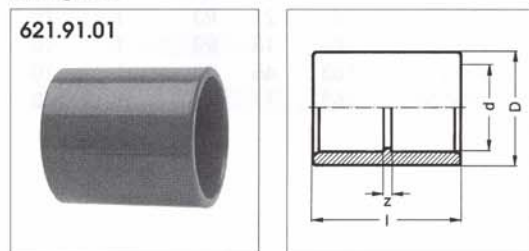

| d   | DN  | D   | l   | z  | Stp. | bar |
|-----|-----|-----|-----|----|------|-----|
| 8   | 5   | 14  | 28  | 3  | 10   | 16  |
| 10  | 6   | 16  | 28  | 3  | 10   | 16  |
| 12  | 8   | 19  | 28  | 3  | 10   | 16  |
| 16  | 10  | 22  | 31  | 3  | 10   | 16  |
| 20  | 15  | 26  | 35  | 3  | 10   | 16  |
| 25  | 20  | 31  | 40  | 3  | 10   | 16  |
| 32  | 25  | 39  | 47  | 3  | 10   | 16  |
| 40  | 32  | 48  | 55  | 3  | 10   | 16  |
| 50  | 40  | 60  | 65  | 3  | 10   | 16  |
| 63  | 50  | 75  | 78  | 3  | 5    | 16  |
| 75  | 65  | 89  | 91  | 4  | 2    | 16  |
| 90  | 80  | 107 | 107 | 5  | 2    | 16  |
| 110 | 100 | 130 | 128 | 7  | 2    | 16  |
| 140 | 125 | 163 | 160 | 8  | 2    | 16  |
| 160 | 150 | 186 | 180 | 8  | 1    | 16  |
| 225 | 200 | 260 | 250 | 10 | 1    | 10  |
| 250 | 225 | 287 | 139 | 8  | 1    | 10  |
| 280 | 250 | 320 | 154 | 8  | 1    | 10  |
| 315 | 300 | 355 | 176 | 11 | 1    | 10  |

**Reduktion kurz mit Klebstutzen und Klebmuffe**  
 Reducing bush  
 Réduction simple  
 Reducción corta

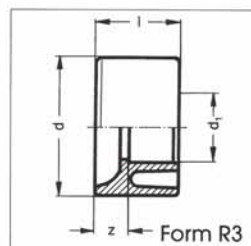
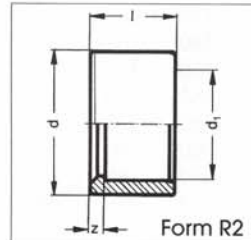

| d - d <sub>1</sub> | DN - DN <sub>1</sub> | l   | z  | Form | Stp. | bar |
|--------------------|----------------------|-----|----|------|------|-----|
| 16- 12             | 10- 8                | 14  | 2  | R2   | 10   | 16  |
| 20- 16             | 15- 10               | 16  | 2  | R2   | 10   | 16  |
| 25- 16             | 20- 10               | 19  | 5  | R2   | 10   | 16  |
| 25- 20             | 20- 15               | 19  | 3  | R2   | 10   | 16  |
| 32- 16             | 25- 10               | 22  | 8  | R3   | 10   | 16  |
| 32- 20             | 25- 15               | 22  | 6  | R3   | 10   | 16  |
| 32- 25             | 25- 20               | 22  | 3  | R2   | 10   | 16  |
| 40- 16             | 32- 10               | 26  | 12 | R3   | 10   | 16  |
| 40- 20             | 32- 15               | 26  | 10 | R3   | 10   | 16  |
| 40- 25             | 32- 20               | 26  | 7  | R3   | 10   | 16  |
| 40- 32             | 32- 25               | 26  | 4  | R2   | 10   | 16  |
| 50- 20             | 40- 15               | 31  | 15 | R3   | 10   | 16  |
| 50- 25             | 40- 20               | 31  | 12 | R3   | 10   | 16  |
| 50- 32             | 40- 25               | 31  | 9  | R3   | 10   | 16  |
| 50- 40             | 40- 32               | 31  | 5  | R2   | 10   | 16  |
| 63- 25             | 50- 20               | 38  | 19 | R3   | 5    | 16  |
| 63- 32             | 50- 25               | 38  | 16 | R3   | 5    | 16  |
| 63- 40             | 50- 32               | 38  | 12 | R3   | 5    | 16  |
| 63- 50             | 50- 40               | 38  | 7  | R2   | 5    | 16  |
| 75- 32             | 65- 25               | 44  | 21 | R3   | 2    | 16  |
| 75- 40             | 65- 32               | 44  | 17 | R3   | 2    | 16  |
| 75- 50             | 65- 40               | 44  | 13 | R3   | 2    | 16  |
| 75- 63             | 65- 50               | 44  | 7  | R2   | 2    | 16  |
| 90- 40             | 80- 32               | 51  | 25 | R3   | 2    | 16  |
| 90- 50             | 80- 40               | 51  | 20 | R3   | 2    | 16  |
| 90- 63             | 80- 50               | 51  | 13 | R3   | 2    | 16  |
| 90- 75             | 80- 65               | 51  | 8  | R2   | 2    | 16  |
| 110- 50            | 100- 40              | 61  | 31 | R3   | 2    | 16  |
| 110- 63            | 100- 50              | 61  | 24 | R3   | 2    | 16  |
| 110- 75            | 100- 65              | 61  | 17 | R3   | 2    | 16  |
| 110- 90            | 100- 80              | 61  | 10 | R2   | 2    | 16  |
| 140- 75            | 125- 65              | 76  | 32 | R3   | 2    | 16  |
| 140- 90            | 125- 80              | 76  | 25 | R3   | 2    | 16  |
| 140-110            | 125-100              | 76  | 15 | R2   | 2    | 16  |
| 160- 90            | 150- 80              | 86  | 34 | R3   | 2    | 16  |
| 160-110            | 150-100              | 86  | 24 | R3   | 2    | 16  |
| 160-140            | 150-125              | 86  | 10 | R2   | 2    | 16  |
| 225-160            | 200-150              | 119 | 33 | R3   | 1    | 10  |
| 225-200            | 200-180              | 119 | 33 | R3   | 1    | 10  |
| 250-225            | 225-200              | 132 | 12 | R3   | 1    | 10  |
| 280-225            | 250-200              | 146 | 27 | R3   | 1    | 10  |
| 280-250            | 250-225              | 146 | 15 | R3   | 1    | 10  |
| 315-225            | 300-200              | 163 | 45 | R3   | 1    | 10  |
| 315-280            | 300-250              | 163 | 17 | R3   | 1    | 10  |



**Reduktion lang** mit Klebstutzen und Klebmuffe  
Reduction bush  
Réduction double  
Reducción larga

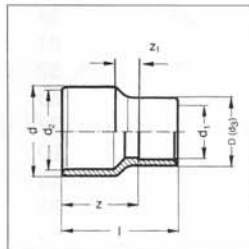

| d     | d <sub>2</sub> | d <sub>1</sub> | d <sub>3</sub> | DN  | DN <sub>2</sub> | DN <sub>1</sub> | DN <sub>3</sub> | D   | l   | z   | z <sub>1</sub> | Stp./bar |
|-------|----------------|----------------|----------------|-----|-----------------|-----------------|-----------------|-----|-----|-----|----------------|----------|
| * 12  | 8              | 10             |                | 8   | -               | 6               |                 | 13  | 27  | 15  | 3              | 10 16    |
| * 16  | 12             | 10             | 16             | 10  | 8               | 6               | 10              | 16  | 30  | 18  | 6              | 10 16    |
| * 20  | 16             | 12             | 16             | 15  | 10              | 8               | 10              | 19  | 33  | 22  | 7              | 10 16    |
| 20    |                | 16             |                | 15  |                 | 10              |                 | 22  | 34  | 20  |                | 10 16    |
| * 25  | 20             | 12             | 16             | 20  | 15              | 8               | 10              | 19  | 38  | 25  | 10             | 10 16    |
| 25    |                | 16             |                | 20  |                 | 10              |                 | 22  | 39  | 25  |                | 10 16    |
| 25    |                | 20             |                | 20  |                 | 15              |                 | 26  | 40  | 24  |                | 10 16    |
| * 32  | 25             | 16             |                | 25  | 20              | 10              |                 | 22  | 44  | 30  | 11             | 10 16    |
| * 32  | 25             | 20             |                | 25  | 20              | 15              |                 | 26  | 46  | 30  | 11             | 10 16    |
| 32    |                | 25             |                | 25  |                 | 20              |                 | 31  | 48  | 30  |                | 10 16    |
| * 40  | 32             | 16             |                | 32  | 25              | 10              |                 | 22  | 50  | 36  | 14             | 10 16    |
| * 40  | 32             | 20             |                | 32  | 25              | 15              |                 | 26  | 52  | 36  | 14             | 10 16    |
| * 40  | 32             | 25             |                | 32  | 25              | 20              |                 | 31  | 55  | 36  | 14             | 10 16    |
| 40    |                | 32             |                | 32  |                 | 25              |                 | 39  | 59  | 37  | 14             | 10 16    |
| * 50  | 40             | 20             |                | 40  | 32              | 15              |                 | 26  | 60  | 44  | 18             | 10 16    |
| * 50  | 40             | 25             |                | 40  | 32              | 20              |                 | 32  | 62  | 44  | 18             | 10 16    |
| * 50  | 40             | 32             |                | 40  | 32              | 25              |                 | 39  | 66  | 44  | 18             | 10 16    |
| 50    |                | 40             |                | 40  |                 | 32              |                 | 48  | 70  | 44  |                | 10 16    |
| * 63  | 50             | 25             |                | 50  | 40              | 20              |                 | 32  | 73  | 54  | 23             | 5 16     |
| * 63  | 50             | 32             |                | 50  | 40              | 25              |                 | 39  | 76  | 54  | 23             | 5 16     |
| * 63  | 50             | 40             |                | 50  | 40              | 32              |                 | 48  | 80  | 54  | 23             | 5 16     |
| 63    |                | 50             |                | 50  |                 | 40              |                 | 60  | 85  | 54  |                | 5 16     |
| * 75  | 63             | 32             | 40             | 65  | 50              | 25              | 32              | 42  | 85  | 62  | 25             | 5 16     |
| * 75  | 63             | 40             | 50             | 65  | 50              | 32              | 40              | 52  | 88  | 62  | 24             | 5 16     |
| * 75  | 63             | 63             |                | 65  | 50              | 50              |                 | 75  | 101 | 62  | 25             | 5 16     |
| * 90  | 75             | 40             | 50             | 80  | 65              | 32              | 40              | 52  | 101 | 74  | 31             | 5 16     |
| * 90  | 75             | 50             | 63             | 80  | 65              | 40              | 50              | 64  | 105 | 74  | 30             | 5 16     |
| * 90  | 75             | 63             | 75             | 80  | 65              | 50              | 65              | 78  | 113 | 74  | 31             | 5 16     |
| * 90  | 75             | 75             |                | 80  | 65              | 65              |                 | 90  | 119 | 74  | 31             | 5 16     |
| * 225 | 200            | 160            |                | 200 | 180             | 150             |                 | 186 | 260 | 174 | 68             | 1 16     |

\* als Reduzier-Muffe (Maße d<sub>2</sub> – d<sub>1</sub>) verwendbar

**Kappe**

Cap  
 Bouchon femelle  
 Tapón

621.96.01

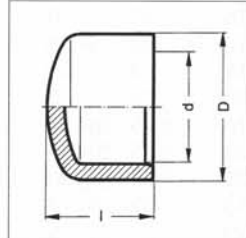

| d   | DN  | D   | l   | Stp. | bar |
|-----|-----|-----|-----|------|-----|
| 12  | 8   | 21  | 16  | 10   | 16  |
| 16  | 10  | 23  | 20  | 10   | 16  |
| 20  | 15  | 28  | 23  | 10   | 16  |
| 25  | 20  | 34  | 26  | 10   | 16  |
| 32  | 25  | 41  | 32  | 10   | 16  |
| 40  | 32  | 52  | 39  | 10   | 16  |
| 50  | 40  | 63  | 48  | 10   | 16  |
| 63  | 50  | 77  | 56  | 5    | 16  |
| 75  | 65  | 90  | 66  | 2    | 10  |
| 90  | 80  | 110 | 77  | 2    | 10  |
| 110 | 100 | 133 | 92  | 2    | 6   |
| 140 | 125 | 161 | 121 | 1    | 6   |
| 160 | 150 | 185 | 136 | 1    | 4   |
| 225 | 200 | 260 | 174 | 1    | 4   |

**Druckschlauchtülle**

Hose nozzle  
 Douille  
 Casquillo portatubo

621.96.04



| d  | DN | d <sub>1</sub> | l   | Stp. | bar |
|----|----|----------------|-----|------|-----|
| 10 | 6  | 8              | 47  | 10   | 10  |
| 12 | 8  | 12             | 51  | 10   | 10  |
| 16 | 10 | 16             | 57  | 10   | 10  |
| 20 | 15 | 20             | 73  | 10   | 10  |
| 25 | 20 | 25             | 79  | 10   | 10  |
| 32 | 25 | 30             | 89  | 10   | 10  |
| 40 | 32 | 40             | 100 | 10   | 10  |
| 50 | 40 | 50             | 114 | 10   | 10  |
| 63 | 50 | 60             | 132 | 10   | 10  |

# Übergangsfittings • Adaptor pipe Fittings Raccords mixtes d'adaptation • Accesorios mixtos de adaptación



## Winkel 90°

mit einseitigem zylindrischem Gewinde;  
Anschluss für Metall- oder Kunststoffgewinde  
Elbow 90° • Coude à 90° • Codo 90°

621.10.02

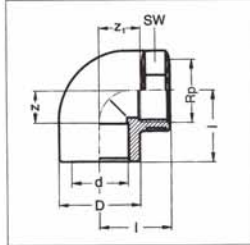

| d-Rp     | DN | D  | l  | z  | z <sub>1</sub> | SW | Stp. | bar |
|----------|----|----|----|----|----------------|----|------|-----|
| 12- 1/4  | 8  | 20 | 19 | 7  | 8              | 20 | 10   | 10  |
| 16- 3/8  | 10 | 25 | 23 | 9  | 12             | 25 | 10   | 10  |
| 20- 1/2  | 15 | 30 | 28 | 12 | 14             | 30 | 10   | 10  |
| 25- 3/4  | 20 | 36 | 34 | 14 | 17             | 36 | 10   | 10  |
| 32-1     | 25 | 47 | 40 | 17 | 22             | 46 | 10   | 10  |
| 40-1 1/4 | 32 | 55 | 49 | 22 | 28             | 55 | 10   | 10  |
| 50-1 1/2 | 40 | 65 | 59 | 27 | 38             | 65 | 10   | 10  |
| 63-2     | 50 | 75 | 71 | 33 | 46             | 75 | 5    | 10  |

## T-Stück 90°

mit zylindrischem Gewinde am Abgang;  
Anschluss für Metall- oder Kunststoffgewinde  
Tee 90° • Té à 90° • Te 90°

621.20.02

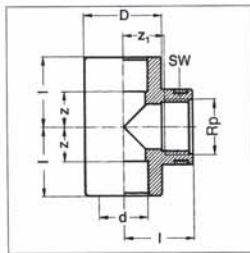

| d-Rp     | DN | D  | l  | z  | z <sub>1</sub> | SW | Stp. | bar |
|----------|----|----|----|----|----------------|----|------|-----|
| 12- 1/4  | 8  | 20 | 19 | 7  | 8              | 20 | 10   | 10  |
| 16- 3/8  | 10 | 25 | 23 | 9  | 12             | 25 | 10   | 10  |
| 20- 1/2  | 15 | 30 | 28 | 12 | 14             | 30 | 10   | 10  |
| 25- 3/4  | 20 | 36 | 33 | 14 | 17             | 36 | 10   | 10  |
| 32-1     | 25 | 46 | 40 | 18 | 22             | 46 | 10   | 10  |
| 40-1 1/4 | 32 | 55 | 49 | 22 | 28             | 55 | 10   | 10  |
| 50-1 1/2 | 40 | 65 | 59 | 27 | 38             | 65 | 10   | 10  |
| 63-2     | 50 | 75 | 71 | 33 | 46             | 75 | 5    | 10  |

**Rohrverschraubung PVC-U/GTW** nur kompl. lieferbar  
mit Klebmuffe und zylindrischem Innengewinde;  
Flachdichtring EPDM; Anschluss für Metallgewinde  
Union (Malleable iron/unplasticized PVC-U)  
Manchon union (Fonte malléable/PVC-U rigide)  
Unión roscada de tubos (fundición maleable/PVC-U rigido)

621.53.02

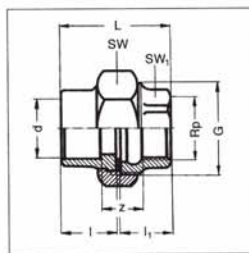

| d-Rp     | DN | G     | L   | l  | l <sub>1</sub> | z  | SW  | SW <sub>1</sub> | Stp. | bar |
|----------|----|-------|-----|----|----------------|----|-----|-----------------|------|-----|
| 16- 3/8  | 10 | 3/4   | 43  | 17 | 23             | 19 | 31  | 22              | 10   | 10  |
| 20- 1/2  | 15 | 1     | 47  | 19 | 25             | 19 | 38  | 25              | 10   | 10  |
| 25- 3/4  | 20 | 1 1/4 | 53  | 22 | 28             | 19 | 47  | 31              | 10   | 10  |
| 32-1     | 25 | 1 1/2 | 59  | 25 | 31             | 20 | 53  | 38              | 10   | 10  |
| 40-1 1/4 | 32 | 2     | 65  | 29 | 33             | 20 | 66  | 47              | 10   | 10  |
| 50-1 1/2 | 40 | 2 1/4 | 73  | 34 | 36             | 23 | 72  | 53              | 10   | 10  |
| 63-2     | 50 | 2 3/4 | 86  | 41 | 42             | 24 | 89  | 66              | 5    | 10  |
| 75-2 1/2 | 65 | 3 1/2 | 96  | 47 | 46             | 25 | 109 | 83              | 2    | 10  |
| 90-3     | 80 | 4     | 111 | 56 | 52             | 30 | 123 | 96              | 2    | 10  |

**Rohrverschraubung PVC-U/GTW** nur kompl. lieferbar mit Klebmuffe und kegligem Außengewinde;  
 Flachdichtring EPDM; Anschluss für Metallgewinde  
 Union (Malleable iron/unplasticized PVC-U)  
 Manchon union (Fonte malléable/PVC-U rigide)  
 Unión roscada de tubos (fundición maleable/PVC-U rígido)

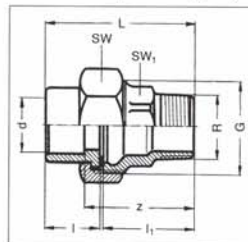

| d - R    | DN | G     | L   | I  | I <sub>1</sub> | z  | SW | SW <sub>1</sub> | Stp. | bar |
|----------|----|-------|-----|----|----------------|----|----|-----------------|------|-----|
| 16- 3/8  | 10 | 3/4   | 56  | 17 | 39             | 45 | 31 | 21              | 10   | 10  |
| 20- 1/2  | 15 | 1     | 62  | 19 | 43             | 49 | 38 | 25              | 10   | 10  |
| 25- 3/4  | 20 | 1 1/4 | 71  | 22 | 49             | 55 | 47 | 31              | 10   | 10  |
| 32-1     | 25 | 1 1/2 | 78  | 25 | 53             | 59 | 53 | 38              | 10   | 10  |
| 40-1 1/4 | 32 | 2     | 87  | 29 | 58             | 65 | 66 | 47              | 10   | 10  |
| 50-1 1/2 | 40 | 2 1/4 | 96  | 35 | 62             | 68 | 72 | 53              | 10   | 10  |
| 63-2     | 50 | 2 3/4 | 112 | 41 | 71             | 76 | 89 | 66              | 5    | 10  |

**Rohrverschraubung PVC-U/V2A** nur kompl. lieferbar mit Klebmuffe und zylindrischem Innengewinde;  
 Flachdichtring EPDM; Anschluss für Metallgewinde  
 Union (Stainless steel/unplasticized PVC-U)  
 Manchon union (Acier inoxydable/PVC-U rigide)  
 Unión roscada de tubos (Acero inoxidable/PVC-U rígido)

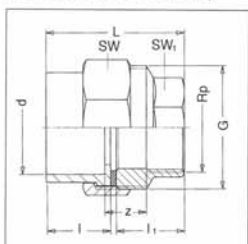

| d - Rp   | DN  | G     | L   | I  | I <sub>1</sub> | z  | SW  | SW <sub>1</sub> | Stp. | bar |
|----------|-----|-------|-----|----|----------------|----|-----|-----------------|------|-----|
| 20- 1/2  | 15  | 1     | 47  | 19 | 25             | 18 | 38  | 27              | 10   | 10  |
| 25- 3/4  | 20  | 1 1/4 | 53  | 22 | 28             | 19 | 47  | 32              | 10   | 10  |
| 32-1     | 25  | 1 1/2 | 59  | 25 | 31             | 20 | 52  | 38              | 10   | 10  |
| 40-1 1/4 | 32  | 2     | 65  | 29 | 33             | 20 | 66  | 47              | 10   | 10  |
| 50-1 1/2 | 40  | 2 1/4 | 73  | 34 | 36             | 23 | 72  | 53              | 10   | 10  |
| 63-2     | 50  | 2 3/4 | 86  | 41 | 42             | 24 | 87  | 65              | 5    | 10  |
| 75-2 1/2 | 65  | 3 1/2 | 96  | 47 | 46             | 25 | 110 | 82              | 2    | 10  |
| 90-3     | 80  | 4     | 111 | 56 | 52             | 30 | 120 | 95              | 2    | 10  |
| 110-4    | 100 | 5     | 129 | 66 | 60             | 32 | 150 | 123             | 1    | 10  |

**Rohrverschraubung PVC-U/V2A** nur kompl. lieferbar mit Klebmuffe und kegligem Außengewinde;  
 Flachdichtring EPDM; Anschluss für Metallgewinde  
 Union (Stainless steel/unplasticized PVC-U)  
 Manchon union (Acier inoxydable/PVC-U rigide)  
 Unión roscada de tubos (Acero inoxidable/PVC-U rígido)

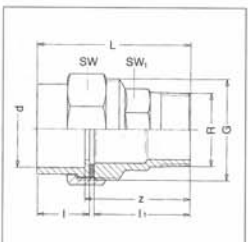

| d - R    | DN  | G     | L   | I  | I <sub>1</sub> | z   | SW  | SW <sub>1</sub> | Stp. | bar |
|----------|-----|-------|-----|----|----------------|-----|-----|-----------------|------|-----|
| 20- 1/2  | 15  | 1     | 65  | 19 | 43             | 49  | 38  | 27              | 10   | 10  |
| 25- 3/4  | 20  | 1 1/4 | 74  | 22 | 49             | 55  | 47  | 27              | 10   | 10  |
| 32-1     | 25  | 1 1/2 | 81  | 25 | 53             | 59  | 52  | 34              | 10   | 10  |
| 40-1 1/4 | 32  | 2     | 90  | 29 | 58             | 64  | 66  | 43              | 10   | 10  |
| 50-1 1/2 | 40  | 2 1/4 | 99  | 34 | 62             | 68  | 72  | 50              | 10   | 10  |
| 63-2     | 50  | 2 3/4 | 115 | 41 | 71             | 77  | 87  | 61              | 5    | 10  |
| 75-2 1/2 | 65  | 3 1/2 | 128 | 47 | 78             | 84  | 110 | 80              | 2    | 10  |
| 90-3     | 80  | 4     | 146 | 56 | 87             | 95  | 120 | 80              | 2    | 10  |
| 110-4    | 100 | 5     | 169 | 66 | 100            | 102 | 150 | 123             | 1    | 10  |

# Übergangsfittings • Adaptor pipe Fittings Raccords mixtes d'adaptation • Accesorios mixtos de adaptación



## Rohrverschraubung

mit Klebmuffe und kegeligem Innengewinde;  
Runddichtring EPDM; Anchl. f. Kunststoffgewinde

**Einzelteile:**

|                |                     |
|----------------|---------------------|
| Einlegeteil    | 621.60.01, Seite 11 |
| Einschraubteil | 621.63.16, Seite 19 |
| Überwurfmutter | 621.69.00, Seite 11 |
| Runddichtring  | 648.41.00, Seite 28 |
| Runddichtring  | 649.41.00, Seite 28 |

Union • Manchon union • Unión roscada de tubos

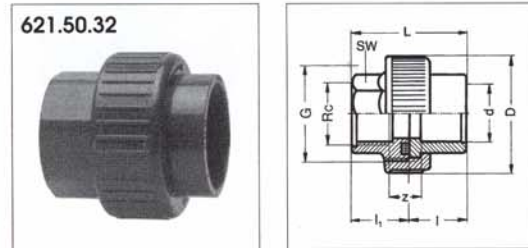

| d - Rc                           | DN | G                             | D   | L  | l  | l <sub>1</sub> | z  | SW | Stp. | bar |
|----------------------------------|----|-------------------------------|-----|----|----|----------------|----|----|------|-----|
| 16- <sup>3</sup> / <sub>8</sub>  | 10 | <sup>3</sup> / <sub>4</sub>   | 35  | 41 | 17 | 24             | 16 | 22 | 10   | 10  |
| 20- <sup>1</sup> / <sub>2</sub>  | 15 | 1                             | 43  | 45 | 19 | 26             | 16 | 27 | 10   | 10  |
| 25- <sup>3</sup> / <sub>4</sub>  | 20 | 1 <sup>1</sup> / <sub>4</sub> | 53  | 51 | 22 | 29             | 16 | 36 | 10   | 10  |
| 32-1                             | 25 | 1 <sup>1</sup> / <sub>2</sub> | 60  | 57 | 25 | 32             | 16 | 41 | 10   | 10  |
| 40-1 <sup>1</sup> / <sub>4</sub> | 32 | 2                             | 74  | 67 | 29 | 38             | 20 | 50 | 10   | 10  |
| 50-1 <sup>1</sup> / <sub>2</sub> | 40 | 2 <sup>1</sup> / <sub>4</sub> | 83  | 79 | 34 | 45             | 27 | 60 | 10   | 10  |
| 63-2                             | 50 | 2 <sup>3</sup> / <sub>4</sub> | 103 | 97 | 41 | 56             | 34 | 70 | 5    | 10  |

## Einschraubteil

mit kegeligem Innengewinde; mit O-Ring Kammer;  
Anschluss für Kunststoffgewinde

Union bush  
Pièce filetée  
Pieza roscada

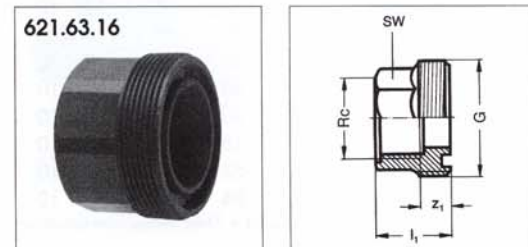

| Rc                            | G                             | l <sub>1</sub> | z <sub>1</sub> | SW | Stp. | bar |
|-------------------------------|-------------------------------|----------------|----------------|----|------|-----|
| <sup>3</sup> / <sub>8</sub>   | <sup>3</sup> / <sub>4</sub>   | 24             | 10             | 22 | 10   | 10  |
| <sup>1</sup> / <sub>2</sub>   | 1                             | 26             | 10             | 27 | 10   | 10  |
| <sup>3</sup> / <sub>4</sub>   | 1 <sup>1</sup> / <sub>4</sub> | 29             | 10             | 36 | 10   | 10  |
| 1                             | 1 <sup>1</sup> / <sub>2</sub> | 32             | 10             | 41 | 10   | 10  |
| 1 <sup>1</sup> / <sub>4</sub> | 2                             | 38             | 10             | 50 | 10   | 10  |
| 1 <sup>1</sup> / <sub>2</sub> | 2 <sup>1</sup> / <sub>4</sub> | 45             | 10             | 60 | 10   | 10  |
| 2                             | 2 <sup>3</sup> / <sub>4</sub> | 56             | 10             | 70 | 10   | 10  |

## Übergang-Gewindemuffe

mit zylindrischem Innengewinde;  
Anschluss für Metall- oder Kunststoffgewinde

Adaptor socket  
Manchon d'adaptation  
Manguito roscada de adaptación

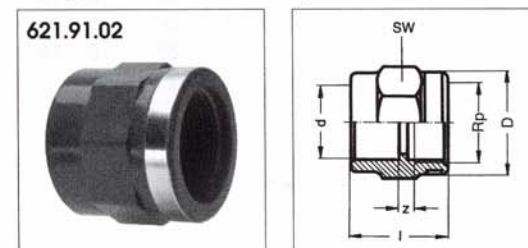

| d - Rp                             | DN  | D   | l   | z  | SW  | Stp. | bar |
|------------------------------------|-----|-----|-----|----|-----|------|-----|
| 12- <sup>1</sup> / <sub>4</sub>    | 8   | 20  | 27  | 4  | 22  | 10   | 10  |
| 16- <sup>3</sup> / <sub>8</sub>    | 10  | 25  | 30  | 5  | 27  | 10   | 10  |
| 20- <sup>1</sup> / <sub>2</sub>    | 15  | 30  | 36  | 5  | 30  | 10   | 10  |
| 25- <sup>3</sup> / <sub>4</sub>    | 20  | 35  | 40  | 5  | 36  | 10   | 10  |
| 32-1                               | 25  | 45  | 47  | 5  | 46  | 10   | 10  |
| 40-1 <sup>1</sup> / <sub>4</sub>   | 32  | 55  | 52  | 5  | 55  | 10   | 10  |
| 50-1 <sup>1</sup> / <sub>2</sub>   | 40  | 65  | 60  | 7  | 65  | 10   | 10  |
| 63-2                               | 50  | 75  | 72  | 7  | 80  | 5    | 10  |
| 75-2 <sup>1</sup> / <sub>2</sub> * | 65  | 89  | 92  | 18 | 90  | 5    | 10  |
| 90-3*                              | 80  | 107 | 107 | 23 | 108 | 5    | 10  |
| 110-4*                             | 100 | 130 | 128 | 28 | 131 | 5    | 10  |

\* Nur für Kunststoffgewinde (ohne Metallring-Verstärkung)  
\* Only for PVC-threading • \*Seulement pour filetage PVC • \*Solo por rosca PVC

**Reduktions-Nippel**

mit zylindrischem Innengewinde;  
 Anschluss für Metall- oder Kunststoffgewinde  
 Reducing bush  
 Mamelon de réduction  
 Boquilla roscada de reducción

621.91.04

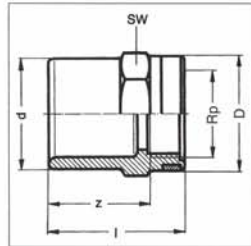

| d - Rp   | DN | D  | l  | z  | SW | Stp. bar |
|----------|----|----|----|----|----|----------|
| 12- 1/4  | 8  | 20 | 27 | 17 | 22 | 10 10    |
| 20- 3/8  | 15 | 25 | 35 | 24 | 27 | 10 10    |
| 25- 1/2  | 20 | 30 | 42 | 27 | 32 | 10 10    |
| 32- 3/4  | 25 | 35 | 48 | 32 | 36 | 10 10    |
| 40-1     | 32 | 45 | 56 | 38 | 46 | 10 10    |
| 50-1 1/4 | 40 | 55 | 66 | 46 | 55 | 10 10    |
| 63-1 1/2 | 50 | 65 | 77 | 55 | 65 | 5 10     |

**Übergangs-Muffen-Nippel**

mit Klebmuffe bzw. Stutzen  
 kegliges Außengewinde 3/8 - 2;  
 zylindrisches Außengewinde 2 1/2 - 4;  
 Anschluss für Kunststoffgewinde  
 Adaptor socket  
 Embout d'adaptation  
 Pieza de adaptación

621.91.17

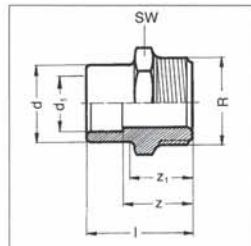

| d - d <sub>1</sub> - R | DN - DN <sub>1</sub> | l   | z  | z <sub>1</sub> | SW  | Stp. bar |
|------------------------|----------------------|-----|----|----------------|-----|----------|
| 16- 12- 3/8            | 10- 8                | 35  | 23 | 21             | 22  | 10 10    |
| 20- 16- 3/8            | 15- 10               | 37  | 23 | 21             | 27  | 10 10    |
| 20- 16- 1/2            | 15- 10               | 42  | 28 | 26             | 24  | 10 10    |
| 25- 20- 1/2            | 20- 15               | 45  | 29 | 26             | 30  | 10 10    |
| 25- 20- 3/4            | 20- 15               | 47  | 31 | 28             | 30  | 10 10    |
| 32- 25- 3/4            | 25- 20               | 50  | 31 | 28             | 36  | 10 10    |
| 32- 25-1               | 25- 20               | 54  | 35 | 32             | 36  | 10 10    |
| 40- 32-1               | 32- 25               | 58  | 36 | 32             | 46  | 10 10    |
| 40- 32-1 1/4           | 32- 25               | 60  | 38 | 34             | 46  | 10 10    |
| 50- 40-1 1/4           | 40- 32               | 65  | 39 | 34             | 55  | 10 10    |
| 50- 40-1 1/2           | 40- 32               | 65  | 41 | 35             | 55  | 10 10    |
| 63- 50-1 1/2           | 50- 40               | 73  | 42 | 35             | 65  | 5 10     |
| 63- 50-2               | 50- 40               | 78  | 47 | 40             | 65  | 5 10     |
| 75- 63-2               | 65- 50               | 84  | 46 | 40             | 80  | 5 10     |
| 90- 75-2 1/2*          | 80- 65               | 99  | 55 | 48             | 95  | 5 10     |
| 110- 90-3*             | 100- 80              | 113 | 62 | 52             | 115 | 5 10     |
| 125-110-4*             | 100-100              | 120 | 59 | 54             | 130 | 5 10     |

\* Mit zylindrischem Außengewinde • \* With cylindric male thread • \* Avec filetage male cylindrique

**Übergangs-Gewindemuffe PVC-U**

mit Klebmuffe;  
 zylindrisches Innengewinde Rotguss vernickelt  
 Adaptor socket  
 Manchon d'adaptation  
 Manguito roscada de adaptación

620.91.02

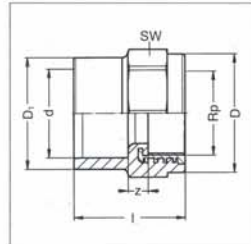

| d - Rp   | DN | D  | D <sub>1</sub> | l  | z  | SW | Stp. bar |
|----------|----|----|----------------|----|----|----|----------|
| 16- 1/2  | 10 | 35 | 29             | 40 | 11 | 36 | 10 16    |
| 20- 1/2  | 15 | 35 | 29             | 40 | 10 | 36 | 10 16    |
| 25- 3/4  | 20 | 43 | 34             | 42 | 8  | 44 | 10 16    |
| 32-1     | 25 | 50 | 43             | 52 | 12 | 51 | 10 16    |
| 40-1 1/4 | 32 | 62 | 52             | 59 | 13 | 63 | 10 16    |
| 50-1 1/2 | 40 | 69 | 64             | 65 | 14 | 70 | 10 16    |
| 63-2     | 50 | 84 | 79             | 78 | 19 | 85 | 5 16     |

**Übergangs-Muffen-Nippel PVC-U**

mit Klebmuffe;  
kegliges Außengewinde Rotguss vernickelt  
Adaptor socket  
Embout d'adaptation  
Pieza roscada de adaptación

620.91.07

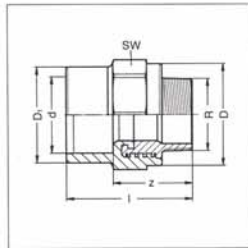

| d - R    | DN | D  | D <sub>1</sub> | I   | z  | SW | Stp. bar |
|----------|----|----|----------------|-----|----|----|----------|
| 16- 1/2  | 10 | 35 | 29             | 55  | 41 | 36 | 10 16    |
| 20- 1/2  | 15 | 35 | 29             | 55  | 39 | 36 | 10 16    |
| 25- 3/4  | 20 | 43 | 34             | 58  | 39 | 44 | 10 16    |
| 32-1     | 25 | 50 | 43             | 70  | 48 | 51 | 10 16    |
| 40-1 1/4 | 32 | 62 | 52             | 79  | 53 | 63 | 10 16    |
| 50-1 1/2 | 40 | 69 | 64             | 85  | 54 | 70 | 10 16    |
| 63-2     | 50 | 84 | 79             | 103 | 65 | 85 | 5 16     |

**Wandscheibe PVC-U**

mit Klebmuffe;  
zylindrisches Innengewinde Rotguss vernickelt  
Bracket  
Applique  
Apliche de latón/PVC-U

620.100

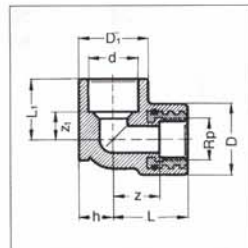

| d - Rp  | DN | D <sub>1</sub> | L  | L <sub>1</sub> | h  | †** | z  | z <sub>1</sub> | Stp. bar |
|---------|----|----------------|----|----------------|----|-----|----|----------------|----------|
| 20- 1/2 | 15 | 29             | 35 | 27             | 15 | 40  | 21 | 11             | 10 16    |
| 25- 3/4 | 20 | 43             | 43 | 35             | 22 | 50  | 28 | 19             | 10 16    |

\*\* Abstand der Befestigungslöcher

**Winkel 90°**

mit beidseitigem kegligem Innengewinde;  
Anschluss für Kunststoffgewinde  
Elbow 90°  
Coude à 90°  
Codo 90°

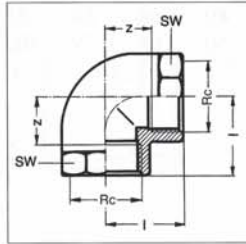
**621.10.16**

| Rc    | l  | z  | SW | Stp. | bar |
|-------|----|----|----|------|-----|
| 1/2   | 28 | 14 | 30 | 10   | 10  |
| 3/4   | 33 | 17 | 36 | 10   | 10  |
| 1     | 40 | 22 | 46 | 10   | 10  |
| 1 1/4 | 49 | 28 | 55 | 10   | 10  |
| 1 1/2 | 59 | 38 | 65 | 10   | 10  |

**T-Stück 90°**

mit allseitigem kegligem Innengewinde;  
Anschluss für Kunststoffgewinde  
Tee 90°  
Té à 90°  
Te 90°

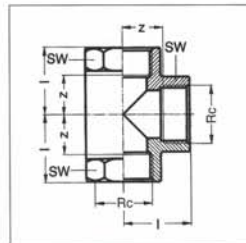
**621.20.16**

| Rc    | l  | z  | SW | Stp. | bar |
|-------|----|----|----|------|-----|
| 1/2   | 28 | 14 | 30 | 10   | 10  |
| 3/4   | 33 | 17 | 36 | 10   | 10  |
| 1     | 40 | 22 | 46 | 10   | 10  |
| 1 1/4 | 49 | 28 | 55 | 10   | 10  |
| 1 1/2 | 59 | 38 | 65 | 10   | 10  |

**Doppelnippel**

mit kegligem Außengewinde;  
Anschluss für Kunststoffgewinde  
Hexagon nipple  
Mamelon double  
Boquilla double con roscas en los dos extremos

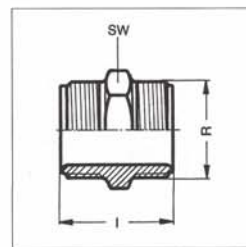
**621.91.19**

| R     | DN | l  | SW | Stp. | bar |
|-------|----|----|----|------|-----|
| 3/8   | 10 | 34 | 22 | 10   | 10  |
| 1/2   | 15 | 42 | 24 | 10   | 10  |
| 3/4   | 20 | 47 | 30 | 10   | 10  |
| 1     | 25 | 53 | 36 | 10   | 10  |
| 1 1/4 | 32 | 56 | 46 | 10   | 10  |
| 1 1/2 | 40 | 57 | 55 | 10   | 10  |
| 2     | 50 | 68 | 65 | 10   | 10  |



## Gewindefittings

Pipe Fittings threaded • Raccords filetés • Accesorios roscados



### Kappe

mit zylindrischem Innengewinde

Cap

Bouchon femelle

Tapón hembra (rosca interior)

621.96.06

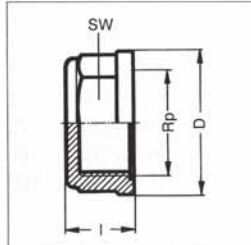

| Rp    | D  | I  | SW | Stp. | bar |
|-------|----|----|----|------|-----|
| 1/8   | 20 | 14 | 17 | 10   | 10  |
| 1/4   | 26 | 16 | 22 | 10   | 10  |
| 3/8   | 31 | 19 | 27 | 10   | 10  |
| 1/2   | 37 | 21 | 32 | 10   | 10  |
| 3/4   | 43 | 24 | 36 | 10   | 10  |
| 1     | 52 | 26 | 46 | 10   | 10  |
| 1 1/4 | 62 | 29 | 55 | 10   | 10  |
| 1 1/2 | 66 | 31 | 60 | 10   | 10  |
| 2     | 82 | 36 | 75 | 5    | 10  |

### Druckschlauchtülle

mit kegligem Außengewinde

Hose nozzle

Douille

Casquillo portatubo

621.96.07

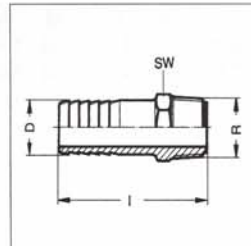

| R     | DN | D  | I   | SW | Stp. | bar |
|-------|----|----|-----|----|------|-----|
| 1/4   | 8  | 12 | 51  | 17 | 10   | 10  |
| 3/8   | 10 | 16 | 57  | 19 | 10   | 10  |
| 1/2   | 15 | 20 | 73  | 24 | 10   | 10  |
| 3/4   | 20 | 25 | 79  | 30 | 10   | 10  |
| 1     | 25 | 30 | 89  | 36 | 10   | 10  |
| 1 1/4 | 32 | 40 | 100 | 50 | 10   | 10  |
| 1 1/2 | 40 | 50 | 114 | 55 | 10   | 10  |
| 2     | 50 | 60 | 132 | 65 | 10   | 10  |

### Stopfen 621.96.19

mit kegligem Außengewinde

Anschluss für Kunststoffgewinde

Plug

Bouchon mâle

Tapón macho (rosca exterior)

621.96.19  
621.96.09

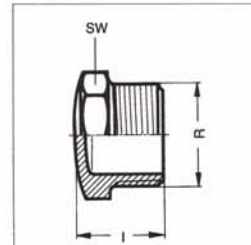

### Stopfen 621.96.09

mit zylindrischem Außengewinde

Anschluss für Kunststoffgewinde

Plug

Bouchon mâle

Tapón macho (rosca exterior)

| R                | G                | I  | SW  | Stp. | bar |
|------------------|------------------|----|-----|------|-----|
| <b>621.96.19</b> | <b>621.96.09</b> |    |     |      |     |
| 3/8              | 3/8              | 21 | 22  | 10   | 10  |
| 1/2              | 1/2              | 27 | 24  | 10   | 10  |
| 3/4              | 3/4              | 29 | 30  | 10   | 10  |
| 1                | 1                | 32 | 36  | 10   | 10  |
| 1 1/4            | 1 1/4            | 36 | 46  | 10   | 10  |
| 1 1/2            | 1 1/2            | 37 | 55  | 10   | 10  |
| 2                | 2                | 42 | 65  | 5    | 10  |
|                  | 2 1/2            | 59 | 80  | 1    | 10  |
|                  | 3                | 76 | 93  | 1    | 10  |
|                  | 4                | 84 | 131 | 1    | 10  |

**Kugelhahn**  
mit Klebmuffe, gesicherte Kugel  
Ball valve  
Robinet à bille  
Valvula de esfera radiales

621.342.250  
621.342.275

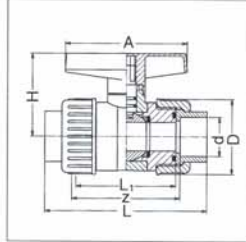

**621.342.250 mit Dichtung EPDM**

**621.342.275 mit Dichtung FPM**

| d  | DN | L   | L <sub>1</sub> | z   | D   | H   | A   | Stp. | bar |
|----|----|-----|----------------|-----|-----|-----|-----|------|-----|
| 20 | 15 | 83  | 64             | 70  | 41  | 51  | 78  | 1    | 16  |
| 25 | 20 | 98  | 76             | 82  | 51  | 61  | 88  | 1    | 16  |
| 32 | 25 | 106 | 81             | 87  | 58  | 70  | 98  | 1    | 16  |
| 40 | 32 | 121 | 92             | 98  | 72  | 81  | 108 | 1    | 16  |
| 50 | 40 | 129 | 95             | 101 | 80  | 90  | 118 | 1    | 16  |
| 63 | 50 | 146 | 115            | 121 | 100 | 110 | 144 | 1    | 16  |

**Kugelhahn**  
mit Muffenflansch  
Ball valve  
Robinet à bille  
Valvula de esfera radiales

621.342.250  
621.342.275

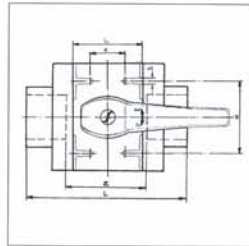

**621.342.250 mit Dichtung EPDM**

**621.342.275 mit Dichtung FPM**

| d   | DN  | K  | L   | z   | L <sub>1</sub> | M   | N'  | P   | R     | S   | T   | $\frac{D}{d}$ | bar |
|-----|-----|----|-----|-----|----------------|-----|-----|-----|-------|-----|-----|---------------|-----|
| 75  | 65  | 60 | 206 | 118 | 112            | 110 | 130 | 5,5 | 84,0  | 8,5 | 127 | 1             | 10  |
| 90  | 80  | 60 | 236 | 134 | 124            | 124 | 140 | 6,0 | 92,5  | 8,5 | 135 | 1             | 10  |
| 110 | 100 | 80 | 276 | 154 | 144            | 136 | 160 | 8,0 | 102,5 | 8,5 | 148 | 1             | 10  |

## Armaturen

Valves • Robinetterie • Valvulas



### Fußventil Dichtung EPDM

Ball foot valve  
Soupape à bille avec crépine  
Valvula de pie

21.10.140

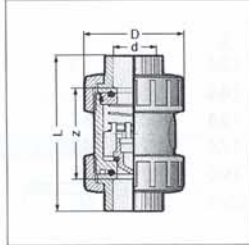

| d  | DN | D   | L   | z  | Stp. | bar |
|----|----|-----|-----|----|------|-----|
| 20 | 15 | 50  | 80  | 48 | 1    | 16  |
| 25 | 20 | 60  | 91  | 53 | 1    | 16  |
| 32 | 25 | 68  | 102 | 58 | 1    | 16  |
| 40 | 32 | 80  | 120 | 68 | 1    | 16  |
| 50 | 40 | 96  | 140 | 78 | 1    | 16  |
| 63 | 50 | 116 | 169 | 93 | 1    | 16  |

### Rückschlagventil mit Klebmuffe, federbelastet

Feder aus Edelstahl mit PTFE Ummantelung  
Ball check valve  
Soupapa de retenue à bille  
Valvula contra retrógrado

621.360.000/621.360.025

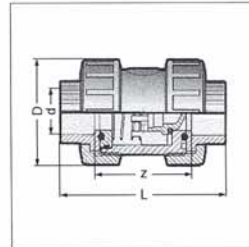

### 621.360.000 Dichtung EPDM

| d  | DN | D   | L   | z  | Stp. | bar |
|----|----|-----|-----|----|------|-----|
| 20 | 15 | 50  | 80  | 48 | 1    | 16  |
| 25 | 20 | 60  | 91  | 53 | 1    | 16  |
| 32 | 25 | 68  | 102 | 58 | 1    | 16  |
| 40 | 32 | 80  | 120 | 68 | 1    | 16  |
| 50 | 40 | 96  | 140 | 78 | 1    | 16  |
| 63 | 50 | 116 | 169 | 93 | 1    | 16  |

### Schrägsitzventil mit Klebstutzen

Dichtung Polybuten  
Angle seat valve  
Robinet à soupape à siège ablique  
Valvula con asiento oblicuo

621.300.000

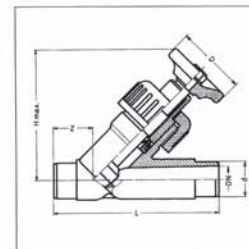

| d  | DN | L   | H   | D   | z  | Stp. | bar |
|----|----|-----|-----|-----|----|------|-----|
| 16 | 10 | 114 | 105 | 50  | 24 | 1    | 10  |
| 20 | 15 | 124 | 135 | 63  | 33 | 1    | 10  |
| 25 | 20 | 144 | 135 | 63  | 33 | 1    | 10  |
| 32 | 25 | 154 | 143 | 63  | 37 | 1    | 10  |
| 40 | 32 | 174 | 182 | 80  | 48 | 1    | 10  |
| 50 | 40 | 194 | 204 | 80  | 48 | 1    | 10  |
| 63 | 50 | 224 | 246 | 100 | 60 | 1    | 10  |

**Schrägsitz-Rückschlagventil mit Klebstutzen,**  
für horizontalen oder vertikalen Einbau

Angle seat valve  
Robinet à soupape  
Valvula de asiento

621.303.000

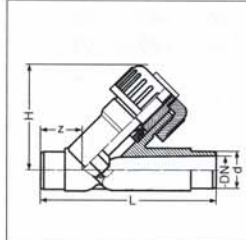

**Dichtung EPDM**

| d  | DN | L   | H   | z  | Stp. | bar |
|----|----|-----|-----|----|------|-----|
| 20 | 15 | 124 | 65  | 33 | 1    | 10  |
| 25 | 20 | 144 | 75  | 33 | 1    | 10  |
| 32 | 25 | 154 | 90  | 37 | 1    | 10  |
| 40 | 32 | 174 | 102 | 48 | 1    | 10  |
| 50 | 40 | 194 | 123 | 48 | 1    | 10  |
| 63 | 50 | 224 | 144 | 60 | 1    | 10  |

## Zubehör

Accessories • Accessoires • Accesorios complementarios



### Flachdichtung EPDM

PVC-U/GTW und V2A  
für Rohrverschraubung  
Gasket  
Joint plat  
Junta plana de empaquetadura  
para unión roscada de tubos

648.40.00

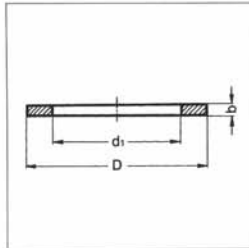

| d - R    | DN | D   | d <sub>1</sub> | b | Stp. |
|----------|----|-----|----------------|---|------|
| 16- 3/8  | 10 | 24  | 16             | 2 | 10   |
| 20- 1/2  | 15 | 30  | 22             | 3 | 10   |
| 25- 3/4  | 20 | 39  | 26             | 3 | 10   |
| 32-1     | 25 | 44  | 32             | 3 | 10   |
| 40-1 1/4 | 32 | 55  | 42             | 3 | 10   |
| 50-1 1/2 | 40 | 62  | 46             | 3 | 10   |
| 63-2     | 50 | 78  | 60             | 3 | 10   |
| 75-2 1/2 | 65 | 97  | 75             | 3 | 10   |
| 90-3     | 80 | 110 | 88             | 3 | 10   |

### Flachdichtring EPDM

für Bundbuchsen gerillt und flach  
und Flansch 620.74.00  
Flat Gasket  
Joint Plat  
Junta plane de empaquetadura para collares

648.40.01

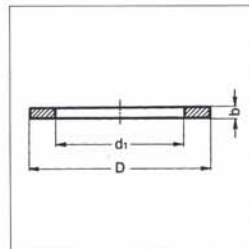

### für PVC-U Flansch 621.70.00 nicht geeignet

| d   | DN  | D   | d   | b | Stp. |
|-----|-----|-----|-----|---|------|
| 16  | 10  | 27  | 16  | 2 | 10   |
| 20  | 15  | 32  | 20  | 2 | 10   |
| 25  | 20  | 39  | 25  | 2 | 10   |
| 32  | 25  | 48  | 32  | 2 | 10   |
| 40  | 32  | 59  | 40  | 3 | 10   |
| 50  | 40  | 71  | 50  | 3 | 10   |
| 63  | 50  | 88  | 63  | 3 | 10   |
| 75  | 65  | 104 | 75  | 3 | 10   |
| 90  | 80  | 123 | 90  | 3 | 10   |
| 110 | 100 | 148 | 110 | 4 | 10   |
| 140 | 125 | 186 | 140 | 4 | 10   |
| 160 | 150 | 211 | 160 | 4 | 10   |
| 225 | 200 | 272 | 225 | 5 | 10   |

### Flachdichtung mit Stahleinlage

für Bundbuchsen gerillt und flach,  
Fabrikat Kroll + Ziller  
Flat Gasket  
Joint plat  
Junta plana especial para collares

670.41.01 EPDM  
671.41.01 NBR

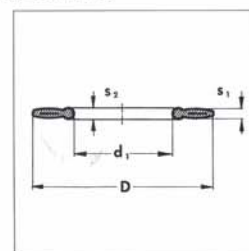

| d   | DN  | D   | d <sub>1</sub> | s <sub>1</sub> | s <sub>2</sub> | Stp. |
|-----|-----|-----|----------------|----------------|----------------|------|
| 16  | 10  | 46  | 16             | 3              | 4              | 10   |
| 20  | 15  | 51  | 20             | 3              | 4              | 10   |
| 25  | 20  | 61  | 25             | 3              | 4              | 10   |
| 32  | 25  | 71  | 32             | 3              | 4              | 10   |
| 40  | 32  | 82  | 40             | 3              | 4              | 10   |
| 50  | 40  | 92  | 50             | 3              | 4              | 10   |
| 63  | 50  | 107 | 63             | 4              | 5              | 10   |
| 75  | 65  | 127 | 75             | 4              | 5              | 10   |
| 90  | 80  | 142 | 90             | 4              | 5              | 10   |
| 110 | 100 | 162 | 110            | 5              | 6              | 10   |
| 140 | 125 | 192 | 140            | 5              | 6              | 10   |
| 160 | 150 | 218 | 160            | 6              | 8              | 10   |
| 225 | 200 | 273 | 225            | 6              | 8              | 10   |
| 250 | 225 | 328 | 250            | 6              | 8              | 10   |
| 280 | 250 | 328 | 280            | 6              | 8              | 10   |
| 315 | 300 | 378 | 315            | 6              | 8              | 10   |

**Runddichtung**

für Rohrverschraubungen 621.51.01 u. 621.50.32

EPDM und FPM z. B. Viton A®

O-Ring Gasket

Joint torique

Junta redondo de empaquetadura

para unión roscada de tubos

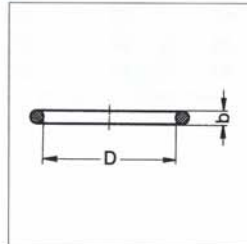

| d - R    | DN  | D     | b    | Stp. |
|----------|-----|-------|------|------|
| 10- 1/8  | 6   | 12,4  | 2,62 | 10   |
| 12- 1/4  | 8   | 12,4  | 2,62 | 10   |
| 16- 3/8  | 10  | 15,6  | 2,62 | 10   |
| 20- 1/2  | 15  | 20,3  | 3,53 | 10   |
| 25- 3/4  | 20  | 28,2  | 3,53 | 10   |
| 32-1     | 25  | 33,0  | 3,53 | 10   |
| 40-1 1/4 | 32  | 40,7  | 5,33 | 10   |
| 50-1 1/2 | 40  | 47,1  | 5,33 | 10   |
| 63-2     | 50  | 59,8  | 5,33 | 10   |
| 75-2 1/2 | 65  | 75,6  | 5,33 | 10   |
| 90-3     | 80  | 91,4  | 5,33 | 10   |
| 110-4    | 100 | 113,7 | 5,33 | 10   |

**Runddichtung**

für Bundbuchsen mit O-Ring-Kammer

EPDM und FPM z. B. Viton A®

O-Ring Gasket

Joint torique

Junta redondo de empaquetadura para collares

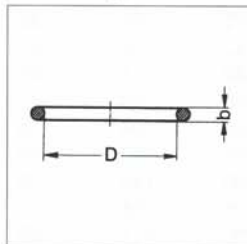

| d   | DN  | D     | b    | Stp. |
|-----|-----|-------|------|------|
| 16  | 10  | 18,6  | 3,53 | 10   |
| 20  | 15  | 23,3  | 3,53 | 10   |
| 25  | 20  | 28,1  | 3,53 | 10   |
| 32  | 25  | 36,0  | 3,53 | 10   |
| 40  | 32  | 43,9  | 5,33 | 10   |
| 50  | 40  | 53,4  | 5,33 | 10   |
| 63  | 50  | 69,3  | 5,33 | 10   |
| 75  | 65  | 81,9  | 5,33 | 10   |
| 90  | 80  | 101,0 | 5,33 | 10   |
| 110 | 100 | 120,0 | 6,99 | 10   |
| 140 | 125 | 151,7 | 6,99 | 10   |
| 160 | 150 | 177,1 | 6,99 | 10   |
| 225 | 200 | 240,7 | 7,00 | 10   |

**Rohrschelle ohne Bügel, Best.-Nr. 65.00.114**
**Rohrschelle mit Bügel, Best.-Nr. 65.00.115**

Pipe Bracket • Collier pour tube

Abrazadera de tubo

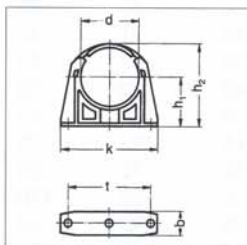
**Maße für Ausführung ohne Bügel**

| d  | DN | k  | h <sup>1</sup> | b  | Stp. |
|----|----|----|----------------|----|------|
| 16 | 10 | 32 | 24             | 16 | 10   |
| 20 | 15 | 32 | 25             | 16 | 10   |
| 25 | 20 | 41 | 26             | 17 | 10   |
| 32 | 25 | 49 | 30             | 16 | 10   |

**Maße für Ausführung mit Bügel**

| d   | DN  | h <sub>1</sub> | h <sub>2</sub> | k   | b  | t   | Stp. |
|-----|-----|----------------|----------------|-----|----|-----|------|
| 40  | 32  | 35             | 68             | 56  | 20 | -   | 10   |
| 50  | 40  | 40             | 77             | 67  | 23 | -   | 10   |
| 63  | 50  | 50             | 94             | 83  | 23 | -   | 10   |
| 75  | 65  | 64             | 107            | 126 | 30 | 109 | 10   |
| 90  | 80  | 73             | 124            | 143 | 30 | 125 | 10   |
| 110 | 100 | 85             | 146            | 163 | 30 | 145 | 10   |
| 140 | 125 | 132            | 209            | 199 | 40 | 181 | 10   |
| 160 | 150 | 150            | 238            | 220 | 40 | 202 | 10   |

## Zubehör

Accessories • Accessoires • Accesorios complementarios



### Abreßzapfen mit O - Ring

Wall inlet plug with gasket

Bouchons étanches à murer avec joint torique

Tapón para introducir en la pared  
con junta redondo

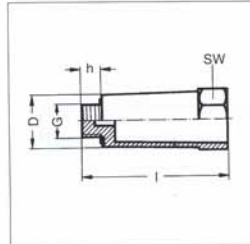

| G             | D  | l  | h  | SW | Stp. |
|---------------|----|----|----|----|------|
| $\frac{3}{8}$ | 29 | 87 | 10 | 32 | 10   |
| $\frac{1}{2}$ | 33 | 87 | 10 | 36 | 10   |
| $\frac{3}{4}$ | 40 | 91 | 14 | 41 | 10   |

9900

### Ersatzdichtung 9910

| d    | b   | Stp. |
|------|-----|------|
| 17,5 | x 3 | 10   |
| 19,2 | x 3 | 10   |
| 25,0 | x 3 | 10   |

### Spezial-Kleber

Solvent cement

Adhésif spécial

Adhesivo



69.298.001 1/4 kg Dose, (ca. 220g netto)

69.298.002 1/2 kg Dose, (ca. 450g netto)

69.298.003 1 kg Dose, (ca. 1000g netto)

### Reiniger

Cleaner

Décapant

Thinner



69.298.009 1/8 Liter Kanister

69.298.010 1 Liter Kanister, (ca 1350g netto)

### Rundpinsel

Round brushes

Pinceaux ronds

Brozha redondo



69.299.001 Ø 4 mm, für Fittings von 10 - 12 mm

69.299.002 Ø 8 mm, für Fittings von 16 - 32 mm

### Flachpinsel

Flat brushes

Pinceaux plats

Brozha plano



69.299.003 25 x 3 mm, für Fittings von 40 - 63 mm

69.299.004 50 x 5 mm, für Fittings von 75 - 160 mm

### Flanschverbindung mit **Flachdichtring**

Flange connection with **flat gasket**

Bride avec **joint plat**

Unión por bridas con **anillo plano**

### Flanschverbindung mit **Runddichtring**

Flange connection with **O - Ring**

Bride avec **joint torique**

Unión por bridas con **anillo redondo**

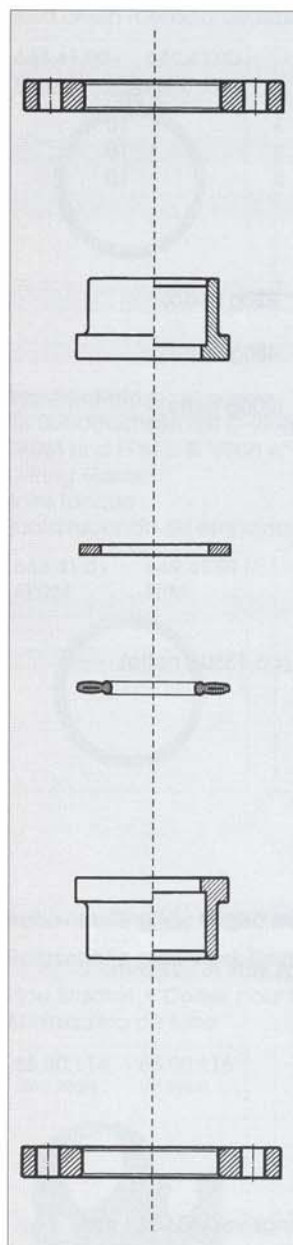

Loser Flansch aus PVC-U  
Nr. 621.70.00\*  
oder  
Loser Flansch aus PP  
mit Stahleinlage  
Nr. 620.74.00

Bundbuchse  
Nr. 621.80.01  
Dichtfläche glatt  
oder  
Nr. 621.79.01  
Dichtfläche gerillt

Flachdichtring  
Nr. 648.40.01 EPDM\*

oder

Flachdichtring  
mit Stahleinlage  
Nr. 670.41.01 EPDM  
oder  
Nr. 671.41.01 NBR

Bundbuchse  
Nr. 621.80.01  
Dichtfläche glatt  
oder  
Nr. 621.79.01  
Dichtfläche gerillt

Loser Flansch aus PVC-U  
Nr. 621.70.00\*  
oder  
Loser Flansch aus PP  
mit Stahleinlage  
Nr. 620.74.00

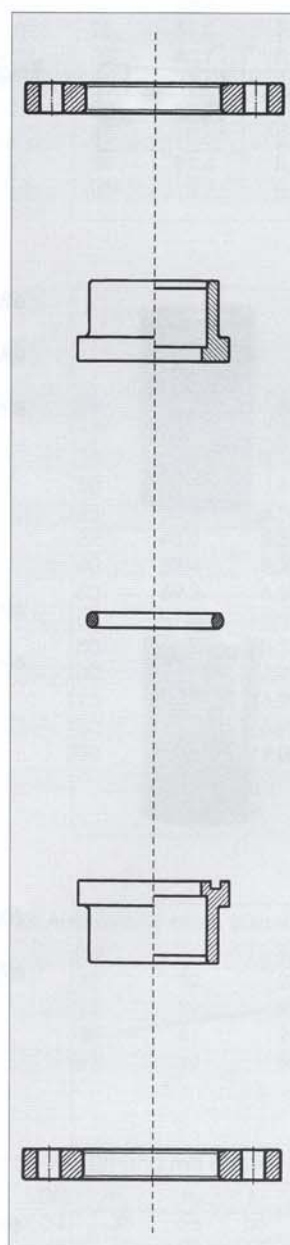

Loser Flansch aus PVC-U  
Nr. 621.70.00  
oder  
Loser Flansch aus PP  
mit Stahleinlage  
Nr. 620.74.00

Bundbuchse  
Nr. 621.80.01  
Dichtfläche glatt

Runddichtring  
Nr. 648.41.01 EPDM  
Nr. 649.41.01 FPM

Bundbuchse  
Nr. 621.81.01  
Dichtfläche mit  
O - Ring-Kammer

Loser Flansch aus PVC-U  
Nr. 621.70.00  
oder  
Loser Flansch aus PP  
mit Stahleinlage  
Nr. 620.74.00

\* Für Flanschverbindungen mit Flachdichtungen ohne Stahleinlage sind Flansche notwendig, die gegenüber den für solche Verbindungen erforderlichen höheren Drehmomenten bei der Schraubenbefestigung eine ausreichende Festigkeit besitzen.

Der PP - Flansch mit Stahleinlage (Best.-Nr. 620.74.00) erfüllt diese Festigkeit.



## Aufgliederung der Verschraubungen

Compositions of unions • Composition des unions  
Composición de las uniones roscadas

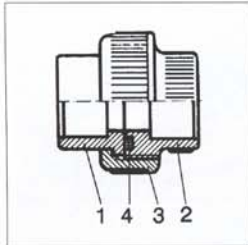

**621.51.01**  
**Rohrverschraubung PVC-U**  
**Runddichtring**

|                                |           |
|--------------------------------|-----------|
| 1 = Einlegeteil aus PVC-U      | 621.60.01 |
| 2 = Einschraubteil aus PVC-U   | 621.64.01 |
| 3 = Überwurfmutter aus PVC-U   | 621.69.00 |
| 4 = Runddichtring aus EPDM     | 648.41.00 |
| 4 = Runddichtring aus Viton A® | 649.41.00 |

**Anwendung:**  
Kunststoff-Rohrleitungen mit normalen Betriebsbedingungen

**Abmessungen:** d = 10 mm bis 110 mm

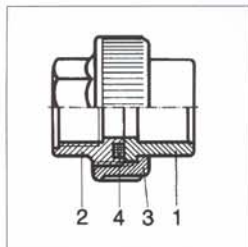

**621.50.32**  
**Rohrverschraubung PVC-U**  
**Anschluß für Kunststoffgewinde**

|                                |           |
|--------------------------------|-----------|
| 1 = Einlegeteil aus PVC-U      | 621.60.01 |
| 2 = Einschraubteil aus PVC-U   | 621.63.16 |
| 3 = Überwurfmutter aus PVC-U   | 621.69.00 |
| 4 = Runddichtring aus EPDM     | 648.41.00 |
| 4 = Runddichtring aus Viton A® | 649.41.00 |

**Anwendung:**  
Kunststoff-Rohrleitungen mit normalen Betriebsbedingungen.  
Übergang auf Kunststoffgewinde

**Abmessungen:** d = 16 - 3/8 bis 63 - 2

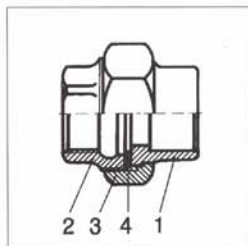

**621.53.02**  
**Rohrverschraubung PVC-U/GTW**  
**Anschluß für Metallgewinde**  
nur komplett lieferbar

|                             |  |
|-----------------------------|--|
| 1 = Einlegeteil aus PVC-U   |  |
| 2 = Einschraubteil aus GTW  |  |
| 3 = Überwurfmutter aus GTW  |  |
| 4 = Flachdichtring aus EPDM |  |

**Anwendung:**  
Übergang auf Metallrohr.

**Abmessungen:** d = 16 - 3/8 bis 90 - 3

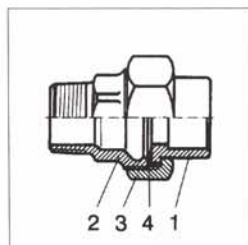

**621.53.07**  
**Rohrverschraubung PVC-U/GTW**  
**Anschluß für Metallgewinde**  
nur komplett lieferbar

|                             |  |
|-----------------------------|--|
| 1 = Einlegeteil aus PVC-U   |  |
| 2 = Einschraubteil aus GTW  |  |
| 3 = Überwurfmutter aus GTW  |  |
| 4 = Flachdichtring aus EPDM |  |

**Anwendung:**  
Übergang auf Metallrohr.

**Abmessungen:** d = 16 - 3/8 bis 63 - 2

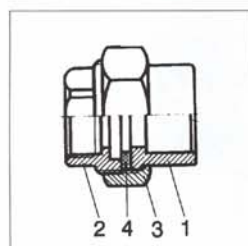

**621.54.02**  
**Rohrverschraubung PVC-U/V2A**  
**Anschluß für Metallgewinde**  
nur komplett lieferbar

|                             |  |
|-----------------------------|--|
| 1 = Einlegeteil aus PVC-U   |  |
| 2 = Einschraubteil aus V2A  |  |
| 3 = Überwurfmutter aus V2A  |  |
| 4 = Flachdichtring aus EPDM |  |

**Anwendung:**  
Übergang auf Metallrohr.

**Abmessungen:** d = 16 - 3/8 bis 90 - 3

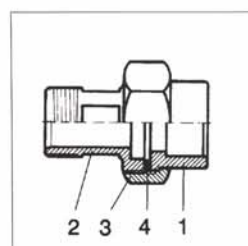

**621.54.07**  
**Rohrverschraubung PVC-U/V2A**  
**Anschluß für Metallgewinde**  
nur komplett lieferbar

|                             |  |
|-----------------------------|--|
| 1 = Einlegeteil aus PVC-U   |  |
| 2 = Einschraubteil aus V2A  |  |
| 3 = Überwurfmutter aus V2A  |  |
| 4 = Flachdichtring aus EPDM |  |

**Anwendung:**  
Übergang auf Metallrohr.

**Abmessungen:** d = 16 - 3/8 bis 90 - 3